

Electronic Flow Meter for Water

Aqua Eye

INSTRUCTION MANUAL

MNT40351 25.07



Please keep this instruction manual in a place where you can take it out and refer to it as soon as it is needed. Also, when reselling or transferring this product, please also attach this instruction manual to the product.

For inquiries about this flow meter and ordering parts, be sure to inform us of the model number and the serial number displayed on the name plate.

Contents

| | | |
|-------|------------------------------------------------------------------------------------|-----|
| 1 | Introduction | 1-1 |
| 2 | Handling precautions | 2-1 |
| 2.1 | Matters to be checked about type and specifications | 2-1 |
| 2.2 | Precautions regarding measured liquid | 2-1 |
| 2.3 | Precautions regarding place of installation | 2-2 |
| 2.4 | Precautions regarding piping | 2-2 |
| 2.5 | Precautions regarding control system | 2-2 |
| 2.6 | Precautions regarding Maintenance & inspection | 2-3 |
| 2.7 | Precautions regarding use for high-pressure gas liquid or inflammable gas liquid | 2-3 |
| 2.8 | Precautions regarding transportation & storage | 2-3 |
| 2.9 | Precautions regarding battery life | 2-3 |
| 2.10 | Precaution regarding batch | 2-4 |
| 3 | Outline of the product | 3-1 |
| 3.1 | Standard specifications | 3-1 |
| 3.1.1 | Measuring unit | 3-1 |
| 3.1.2 | Counting unit | 3-1 |
| 3.1.3 | Flow range | 3-2 |
| 3.2 | Type and specification code | 3-3 |
| 3.3 | External dimension drawing (Unit: mm) | 3-4 |
| (1) | Field indication type | 3-4 |
| (2) | Pulse, & alarm output, and analog output type | 3-4 |
| (3) | Field indication type (for high temperature specification) | 3-4 |
| (4) | Pulse, & alarm output, and analog output type (for high temperature specification) | 3-4 |
| (5) | Batch type | 3-5 |
| 4 | Installation | 4-1 |
| 4.1 | Piping design | 4-1 |
| 4.2 | Mounting | 4-1 |
| 4.2.1 | Mounting precautions | 4-1 |
| 4.2.2 | Precautions regarding the piping | 4-1 |
| 4.2.3 | Checking adjacent pipe | 4-2 |
| 4.2.4 | Precautions regarding execution of heat preservation work | 4-2 |
| 4.2.5 | Precautions regarding outdoor installation | 4-2 |
| 4.2.6 | Change of reading direction | 4-3 |
| 5 | Wiring and setting of printed circuit board | 5-1 |
| 5.1 | Output printed circuit board | 5-1 |
| 5.1.1 | Pulse & alarm output type | 5-1 |
| (1) | Output printed circuit board | 5-1 |
| (2) | Contents of setting | 5-1 |
| 5.1.2 | Analog output type | 5-2 |
| (1) | Output printed circuit board | 5-2 |
| 5.1.3 | Batch type | 5-3 |

| | |
|---------------------------------------------------------------------------------|------|
| (1) Output printed circuit board | 5-3 |
| (2) Contents of setting | 5-3 |
| (3) Batch printed circuit board | 5-4 |
| 5.2 Precautions regarding wiring | 5-5 |
| 5.3 Power line and signal I/O line | 5-5 |
| 5.3.1 Pulse & alarm output type, analog output type | 5-5 |
| 5.3.2 Batch type | 5-5 |
| 5.4 Termination of cable | 5-5 |
| 5.5 Wiring port | 5-5 |
| 5.6 Earth Ground terminal | 5-5 |
| 5.7 Connection | 5-6 |
| 5.7.1 Connection of pulse & alarm output type | 5-6 |
| (1) Voltage no-contact output | 5-6 |
| (2) Open collector output | 5-6 |
| 5.7.2 Connection of analog output type | 5-6 |
| 5.7.3 Connection of batch type | 5-7 |
| 5.7.3.1 Connection of pulse & alarm output unit | 5-7 |
| (1) Voltage no-contact output | 5-7 |
| (2) Open collector output | 5-7 |
| 5.7.3.2 Wiring of power supply & measuring signal unit | 5-7 |
| (1) AC specification | 5-7 |
| (2) 24VDC specification | 5-7 |
| 6 Basic operations | 6-1 |
| 6.1 Field indication type, Pulse & alarm output type, Analog output type | 6-1 |
| 6.1.1 Liquid crystal display / component and function of buttons | 6-1 |
| 6.1.2 Switching of Integrated flow value and Momentary flow rate display | 6-2 |
| 6.2 Batch type | 6-3 |
| 6.2.1 Liquid crystal display / component and function of buttons | 6-3 |
| 6.2.2 Integrated flow value (non-resettable), batch volume, momentary flow rate | 6-4 |
| 6.2.3 Change of batch amount | 6-5 |
| 6.2.4 Actions | 6-6 |
| 6.2.5 Operation | 6-7 |
| 7 Data setting method | 7-1 |
| 7.1 List of set items | 7-1 |
| 7.2 Liquid crystal display / component and function of buttons | 7-2 |
| 7.3 Operating method in setting mode | 7-3 |
| 7.3.1 How to start & end setting mode | 7-3 |
| 7.3.2 How to move set item | 7-4 |
| 7.4 Data setting examples | 7-5 |
| 7.4.1 Setting integration unit | 7-5 |
| 7.4.2 Setting momentary flow rate unit | 7-6 |
| 7.4.3 Setting upper limit alarm value (or lower limit alarm value) | 7-8 |
| 7.4.4 Setting 0 ~ 100% span (analog output span) | 7-10 |
| 7.4.5 Setting the contents of SIG1 (SIG2) output | 7-11 |

| | | |
|------|---------------------------------------------------------------------------------------------------|------|
| 7.5 | Other functions and operations | 7-12 |
| | (1) Changing the pulse unit of unit pulse | 7-12 |
| | (2) Changing the time of hibernation mode | 7-13 |
| | (3) Changing the low cutoff | 7-14 |
| | (4) Changing the momentary flow rate indication updating time | 7-15 |
| | (5) Changing the alarm indication (output) updating time | 7-16 |
| | (6) To write the setting contents to FLASH | 7-17 |
| | (7) To read the contents of setting from FLASH | 7-19 |
| 7.6 | Function and operation of batch type | 7-20 |
| | (1) To use simplified batch function | 7-20 |
| | (2) Changing the reset system | 7-21 |
| | (3) Changing the counting system | 7-22 |
| | (4) Setting the overshoot amount correcting value | 7-23 |
| 7.7 | Factory setting | 7-24 |
| 7.8 | Setting for use | 7-29 |
| 8 | Operation | 8-1 |
| 8.1 | Treatment before flowing of liquid | 8-1 |
| | 8.1.1 Checking after piping installation & wiring | 8-1 |
| | 8.1.2 Flushing | 8-1 |
| 8.2 | Precautions to take before start of operation | 8-1 |
| 8.3 | Operating precautions | 8-1 |
| | 8.3.1 Working flow rate | 8-1 |
| | 8.3.2 Precautions regarding use of high-temperature liquid | 8-1 |
| 9 | Maintenance | 9-1 |
| 9.1 | Measuring section disassembling procedure | 9-1 |
| 9.2 | Simulated output | 9-2 |
| 9.3 | Battery replacing procedure | 9-5 |
| 9.4 | Counting unit resetting procedure | 9-6 |
| 9.5 | Analog output adjusting procedure | 9-7 |
| 9.6 | Pulse width changing procedure | 9-8 |
| 9.7 | Batch type | 9-11 |
| | 9.7.1 Fuse replacing procedure | 9-11 |
| | 9.7.2 Relay replacing procedure | 9-12 |
| 9.8 | Disassembly drawing | 9-13 |
| 10 | Troubleshooting | 10-1 |
| 10.1 | Troubleshooting | 10-1 |
| | (1) Disagreement between actual flow rate and indicated value of integration on flow meter | 10-1 |
| | (2) Disagreement between integrated value on flow meter and output pulse number on flow meter | 10-1 |
| | (3) No change from "0" if momentary flow rate indicated on flow meter even with flowing of liquid | 10-2 |
| | (4) No signal output from flow meter | 10-2 |
| | (5) Integrated volume agrees, but no agreement of momentary flow rate | 10-3 |
| | (6) Disagreement between flow rate and analog output | 10-3 |
| 10.2 | Confirmation items at inquiry | 10-4 |
| 10.3 | Special display screen list | 10-5 |

DATA A: PARAMETER LIST Data A
DATA B: SEGMENT CHARACTERS CORRESPONDENCE LIST Data B

1. Introduction

Thank you for adopting Flow Meter of our make this time.

Before using your instrument, please read carefully this instruction manual which explains specifications, type, installation, etc. of the instrument.

Please note in advance that there may be cases where no revision of this manual is made even for any change in specifications, construction and component parts which is considered as not putting any obstacle from the viewpoints of function and performance.

In case the instrument failed to make normal operation, please inform us of the type and serial No. of the instrument concerned, the contents of trouble, circumstance in which the failure took place, etc. concretely, preferably with presentation of relative sketch, data, etc.

It is to be noted, however, that we cannot assume responsibility for any failure by the instrument of discharging the prescribed functions after a repair made by the user himself regardless of our position.

For any inquiry about troubles, the user is kindly requested to contact our agent from whom you purchased the product or the nearest branch office of our company.



Any unauthorized modification, etc. of this product made by the user presents a risk of spoiling the guarantee of safety or the prescribed function of the product. In case there is any need of modification, etc., the user is kindly requested to inform the dealer from whom you purchased the product or our branch office closest to you of the matter.

In this document, the following symbol marks are used for safe and correct use of the flow meter



: Indicates a general handling precaution.



Warning

: Indicates contents the neglect of which in the handling may eventually lead to death or serious injury.



Caution

: Indicates contents the neglect of which in the handling may eventually lead to injury or production of material damages.

2. Handling precautions



This instrument is inspected sufficiently in the factory before delivery. When received delivery of this instrument, check well the appearance of the instrument to make sure that there is no damage in it. In this section are described precautions necessary for the handling of the instrument.

Please read this section carefully before using the instrument. For other matters, refer to the relative sections as required. For any inquiry about troubles, please contact our agent from whom you purchased the product or the nearest branch office of our company.

2.1 Matters to be checked about type and specifications



Caution

Please check the type and specifications.

This flow meter is assembled and adjusted individually according to specifications for delivery. Check the name plate provided on the counting unit, etc. to make sure that the type and other specifications are conformable to your order.

[Name plate mounting position]

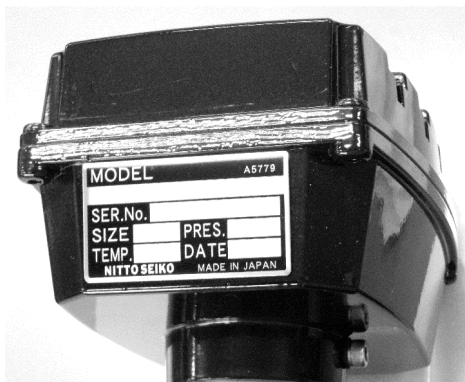

[Contents of indication on the name plate]

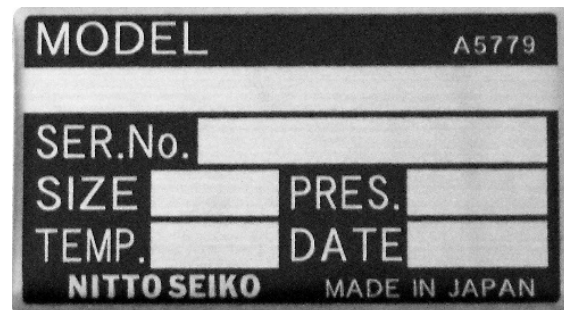

2.2 Precautions regarding measured liquid



Warning

Take care about the liquid to be measured.

If you use this flow meter for any liquid unfit for the material used for the instrument, it may cause injury or material damage with splashing of liquid leaking due to corrosion which develops from the inside of the instrument. Check the corrosion resistance of the material of this product and the liquid concerned.



Warning

Use in the range of working pressure and temperature.

If you use your flow meter at any higher pressure or temperature, it may cause breaking of flow meter body or measuring unit or injury or material damage with splashing of broken pieces or liquid.



Warning

Take protective measures against burning.

In the case of use of any high-temperature liquid (40°C or over), the body and the radiating fins may get very hot and cause burning. Be sure to take protective measures against burning in due consideration of heat radiation, heat preservation and maintenance & inspection.

2.3 Precautions regarding place of installation



Caution

Avoid place with large temperature gradient or large temperature fluctuations.

When the instrument is subject to radiant heat, etc., either take shielding measures or install in a way to secure sufficient ventilation.



Caution

Avoid installing in any corrosive atmosphere.

When using this instrument in a corrosive atmosphere, arrange to secure sufficient ventilation and take protective measures against penetration and accumulation of rain water in the conduit pipe.

2.4 Precautions regarding piping



Caution

Provide a bypass piping.

There is a risk of material damage with breaking of internal component parts of the flow meter due to flushing or exhaustion of air from inside the piping in the initial period of operation.

Please arrange by-pass piping, and start operation following to the "Precautions to take before start of operation".



Caution

Install in a state free from any vibrations or displacement of piping.

If you install the flow meter in a place subject to great vibrations or displacement of piping, it may cause injury or material damage with breaking of flow meter body or measuring unit or splashing of broken pieces or liquid.

Please install the flow meter where less vibration or where no-misaligned piping.



Caution

Install piping at a position not subject to any impact pressure.

If any valve instantly closing the piping is provided close to the flow meter in either the upstream or downstream side, it presents a risk of injury or material damage with breaking of flow meter body or measuring unit due to impact pressure by water hammer, etc

please Install the flow meter where no impact pressure.



Caution

Provide a strainer also on the downstream side.

In order to prevent the internal components of the flowmeter from being damaged and to prevent entry into the process liquid, install a strainer also on the downstream side as necessary.

There is a possibility of physical damage due to contamination into process liquid.

2.5 Precautions regarding control system



Warning

Supplement a control output function other than the output of this product.

There is a risk of loss of safety and/or process specifications due to operating error or interruption of the control signal.

When using this flow meter on an important process line, it is recommended to supplement another control function to the system so as to avoid danger or material damage due to operating error.

2.6 Precautions regarding Maintenance & inspection



Warning

Remove internal pressure and completely eliminate the residual liquid.

If the liquid used is either toxic or corrosive, it may cause injury or material damage at the time of disassembling or inspection of the flow meter. Be sure to remove the internal pressure and remove the internal liquid before working.

2.7 Precautions regarding use for high-pressure gas liquid or inflammable gas liquid



Warning

Use flow meter approved for high-pressure gas or flow meter certified as product of explosion-proof type.

For any high-pressure gas liquid or inflammable gas liquid, use flow meter approved for high-pressure gas or article certified as product of pressure resistant and explosion-proof structure, article certified as product of intrinsically safe construction, etc. If you use a model of general structure, it may cause explosion or fire, leading to injury or material damage.

2.8 Precautions regarding transportation & storage



Pack the flow meter for the storage.

The packing style for storage shall be the same as or close to the state in which the product was delivered from us.

Select a place satisfying the following conditions for the storage:

- Place protected against rain or water.
- Place subject to little vibrations or shocks.
- Place with following temperature & humidity conditions during storage:

Preferably a place with normal temperature & humidity.

Temperature : -10 ~ 60°C

Humidity : 5 ~ 80%RH (without dew condensation)



Caution

Clean well the flow meter.

For storing your flow meter after use, clean well the inside of the liquid end and, after drying, put a cover on the entire instrument for the storage.

2.9 Precautions regarding battery life



Caution

Pay due attention to battery life.

The service life of the battery is about 5 years. Replace the battery at an early time if a battery alarm is indicated or output.

2.10 Precaution regarding batch function



Caution

For the flow meter without batch function setting

Electronic Flow Meter for Small Flow Rate "Nico Eye" (Type: NE3E) does not have batch function.

Please make sure to use setting Set item No. "d1 Simple batch" been "OFF".

3. Outline of the product

Electronic Flow Meter for Water Supply “Aqua Eye” is a flow meter realized by loading an electronic indicating & counting unit on the measuring unit of an impeller type flow meter.

3.1 Standard specifications

3.1.1 Measuring unit

| | | | | | | | |
|---------------------------------|--------------------------------------------------------------------------------------------------------------------------------------------------------------------------------------------------------------------------------------------|----------------------------------------------------------------------------------------------------------------------------------------------|----------------------------------------------------------------------------------|-----------------|-----------------------------------------------|----------------------------|----|
| Nominal size symbol | | 025 | | 040 | | 050 | |
| Volume symbol | | A0 | B0 | A0 | B0 | A0 | B0 |
| Measured liquid | | Water, hot water, etc. | | | | | |
| Nominal size | | 25A | | 40A | | 50A | |
| Liquid viscosity | | 1mPa·s or equivalent | | | | | |
| Liquid temperature | | 0~80°C (Up to 110°C for high temperature specification) | | | | | |
| Liquid pressure | | 2.0MPa or less (By flange standards) | | | | | |
| Measuring accuracy | | Within ±1.0% | | | | | |
| Standard connection | | JIS10K, JIS20K FF, RF | | | | JIS10K FF, RF JIS20K RF | |
| Material | Material symbol | FB | Main body: FCD450, Head cover : SCS14, Inner structure:SCS13※1, Fan wheel:C5191P | | | | |
| | F7 | Main body: FCD450, Head cover : SCS14, Inner structure:SCS13※2, Fan wheel:SUS304 | | | | | |
| | S7 | Main body: SCS13, Head cover : SCS14, Inner structure:SCS13, Fan wheel:SUS304 | | | | | |
| | Note: The nominal size & volume symbol 50B is manufactured only an article of symbol FB or F7. ※1 It is CAC406 in case of the nominal size and volume symbol 50B. ※2 It is SUS304 in case of the nominal size and volume symbol 50B. | | | | | | |
| | | FCD450 : Ductile cast iron, SCS13, SCS14 : Stainless steel casting, C5191P : Phosphor bronze, SUS304 : Stainless steel, CAC406 : Cast bronze | | | | | |
| Material & Permissible Pressure | | Nominal Pressure | Flange standard | Material symbol | Permissible Pressure (Liquid Temp.~110°C) MPa | | |
| | | 10K | JIS10K | FB/F7/S7 | 1.0 | | |
| | | 20K | JIS20K | | 2.5 | | |

3.1.2 Counting unit

| | | | | | | | | |
|---------------------|---------------------------|-----------------------------------------------------------------------------------------------------|-------------------------------------------------------------------------------------------------------------------------------------------------------------------------------------------------------------------------------------------------------------------------------------------------------------------|--------|--------|--------------------------------------------------------------------------------------|---------|--|
| Nominal size symbol | | 025 | | 040 | | 050 | | |
| Volume symbol | | A0 | B0 | A0 | B0 | A0 | B0 | |
| Kind of type | | Field indication type, Pulse & alarm output type, Analog output type, Batch type (For AC or 24V DC) | | | | | | |
| Indication | Display unit | Numerical indication : 7-segment LCD 5W x 10H, 8 digits, mode and alarm indication : LCD 2H | | | | | | |
| | Article | Total Value | Total value : 8 digits "MODE1" For Field indication type, Pulse & alarm output type, and Analog output type For batch type | | | Resettable total value : 8 digits "MODE4" Batch counter : 6 digits "MODE4" | | |
| | | Min. unit | 0.1L~1m³ | | | 1L~1m³ | | |
| | | Flow rate | Flow rate (/h) : 4 1/2 digits "MODE2", Flow rate (/min) : 4 1/2 digits "MODE3" Flow rate (%) : 4 digits "MODE5" | | | | | |
| | | Min. unit /h | 1L/h~0.1m³/h | | | 0.01m³/h~1m³/h | | |
| | | Min. unit /min | 0.01L/min~1L/min | | | 0.1L/min~0.01m³/min | | |
| | Alarm | | Upper limit alarm "HIGH", Lower limit alarm "LOW", Battery alarm "BATT"※3 | | | | | |
| | | | Note 2: Both total value and flow rate cannot be indicated simultaneously. Note 3: Article can be changed by pressing the [MODE] button located on the front of the counting unit. | | | | | |
| Output | Field indication type | output | Without | | | | | |
| | Pulse & alarm output type | No. of output | 2 points | | | | | |
| | | Output assignment | To each of SIG1 and SIG2, one is selected and assigned from among the respective outputs of "Unit pulse", "Unitless pulse", "Upper limit alarm", "Lower limit alarm", "Upper and lower limit alarm" and "Battery alarm" ※3 | | | | | |
| | | Kind of signal | Voltage no-contact output or open collector output Voltage no-contact : Signal level H: Approx. equal to voltage of external power (at no load) (Approx. 24V DC for Batch type) L:0.5V or less (at no load) Output resistance : Approx. 2.3kΩ (short circuit protection resistance : Approx. 100Ω) | | | Open collector : Voltage & current : 27V DC, 30mA Voltage at ON : 0.5V or less | | |
| | | Electronic logic | Positive or negative logic Positive logic : Logic 1 at H (Transistor : OFF) Negative logic : Logic 1 at L (Transistor : ON) | | | | | |
| | | Unit pulse | 0.1L/P~1m³/P | | | 1L/P~1m³/P | | |
| | | Unitless pulse | 13.6mL | 26.2mL | 29.7mL | 79.5mL | 113.3mL | |
| | Pulse signal width | 0.5~20ms or 5~200ms (STD:5ms) | | | | | | |

※3: "Battery alarm" is only for the flow meter with battery

| | | | |
|------------------------------------------------------------------------------------------------------------------------------|------------------------------------------------|----------------------------------------------------------------------------------------------------------------------------------------------------------------------|------------------------------------------------------------------------------------------------------------------------------------------------------------------------------------------------------------------------------------------------------------------------------------------------------------------------------------------|
| Output | Analog output type | No. of output | 1 point |
| | | Output assignment | Flow rate |
| | | Kind of signal | 4 ~ 20mA DC |
| | | Conversion accuracy | ±0.5% (Full scale) |
| | | Resolution | 1/1000 |
| | | Allowable load resistance | 500Ω or less |
| | Batch type | No. of output | 4 points |
| | | Output assignment | SIG1, SIG2: To each of SIG1 and SIG2, one is selected and assigned from among the respective outputs of Unit pulse, Unitless pulse, Upper limit alarm, Lower limit alarm, and Upper and lower limit alarm. Control output: Metering signal 1, Metering signal 2 |
| | | Kind of signal | Pulse output, alarm signal : Refer to kind of signal at article of pulse & alarm signal. Control output : AC type Metering signal 1 : Voltage no-contact, Triac Output voltage Approx. equal to external power voltage Load current 0.5A Metering signal 2 : No-voltage contact Contact capacity 250V AC 2A, 30V DC 2A |
| | | | Control output : 24V DC type Metering signal 1 : Voltage contact Output voltage Approx. equal to external power voltage Load current 2A Metering signal 2 : No-voltage contact Contact capacity 250V AC 2A, 30V DC 2A |
| Note 4: Either one of Pulse & alarm output, Analog output or Batch type is available. Please select type when placing order. | | | |
| Note 5: All output type and batch type require external power supply. | | | |
| Power | Field indication type (without output signal) | Built-in lithium battery (3.6V DC ; Service life 5 years) Vary from use conditions | |
| | Pulse & alarm output type | External power supply is required. Voltage 12~24V DC±10%, Current consumption Approx. 25mA (at 12V DC) / Approx. 38mA (at 24VDC) | |
| | Analog output type | External power supply is required. Voltage 24V DC±10%, Current consumption Approx. 22mA | |
| | Batch type | AC type : External power supply is required, Voltage 100~220V AC±10% 50/60Hz, Current consumption Approx. 50mA (Except for current consumption of Metering signal 1) | |
| | | 24V DC type : External power supply is required Voltage 24V DC ±10%, Current consumption Approx. 120mA (Except for current consumption of Metering signal 1) | |
| Ambient temperature | -10~60°C | | |
| Explosion proof | Non-explosion proof | | |
| Water proof | JIS C 0920 water proof (Except for Batch type) | | |
| Material | Aluminum die casting (Except for Batch type) | | |

3.1.3 Flow range (Unit: m³/h)

| Nominal size & volume symbol | Flow range |
|------------------------------|------------|
| 025A0 | 0.5~ 2.5 |
| 025B0 | 1.0~ 5.0 |
| 040A0 | 1.5~ 7.0 |
| 040B0 | 3.0~ 15.0 |
| 050A0 | 3.0~ 15.0 |
| 050B0 | 6.0~ 25.0 |

Note: When selecting a model of flow meter, please select it so that normal flow range is 40~60% of its Max. flow.

3.2 Type and specification code

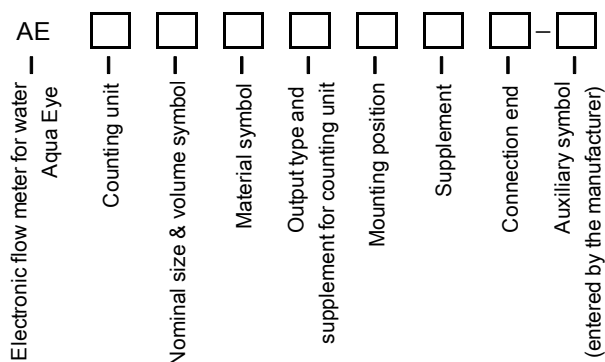

●: Standard; ○: Manufacturable; ×: Unavailable

| Type | Specification code | Specification | 025A0 | 025B0 | 040A0 | 040B0 | 050A0 | 050B0 |
|----------------------------------------------|--------------------|------------------------------------------------------------------|---------------------|-------|-------|-------|-------|-------|
| AE | | Electronic flow meter for water Aqua Eye | ● | ● | ● | ● | ● | ● |
| Counting unit | 3E | Electronic indication | ● | ● | ● | ● | ● | ● |
| Nominal size & volume symbol | 025A0 | Nominal size: 25A Max flow rate: 2.5m ³ /h | ● | | | | | |
| | 025B0 | Nominal size: 25A Max flow rate: 5.0m ³ /h | | ● | | | | |
| | 040A0 | Nominal size: 40A Max flow rate: 7.0m ³ /h | | | ● | | | |
| | 040B0 | Nominal size: 40A Max flow rate: 15m ³ /h | | | | ● | | |
| | 050A0 | Nominal size: 50A Max flow rate: 15m ³ /h | | | | | ● | |
| Material symbol | FB | Body: FCD450, Inner structure: SCS13 ※8, Fan wheel: C5191P | ● | ● | ● | ● | ● | ● |
| | F7 | Body: FCD450, Inner structure: SCS13 ※9, Fan wheel: SUS304 | ○ | ○ | ○ | ○ | ○ | ○ |
| | S7 | Body: SCS13, Inner structure: SCS13, Fan wheel: SUS304 | ○ | ○ | ○ | ○ | ○ | × |
| Output type and supplement for counting unit | 1234 | Field indication type (without output signal) | ● | ● | ● | ● | ● | ● |
| | P034 | Pulse & alarm output ※10 | Non-explosion proof | ● | ● | ● | ● | ● |
| | P00B | | With battery | ○ | ○ | ○ | ○ | ○ |
| | A034 | Analog output | Non-explosion proof | ● | ● | ● | ● | ● |
| | A00B | | With battery | ○ | ○ | ○ | ○ | ○ |
| | PB34 | Batch: AC ※10 | Non-explosion proof | ● | ● | ● | ● | ● |
| PC34 | Batch: 24V DC ※10 | Non-explosion proof | ● | ● | ● | ● | ● | |
| Mounting position | H | Horizontal piping horizontal installation | ● | ● | ● | ● | ● | ● |
| | V | Horizontal piping vertical installation or vertical piping | ○ | ○ | ○ | ○ | ○ | ○ |
| Supplement | 0 | Max. temperature 80°C | ● | ● | ● | ● | ● | ● |
| | 1 | Max temperature 110°C (High temp. type) or in case of batch type | ○ | ○ | ○ | ○ | ○ | ○ |
| Connection end | 010F | JIS10K FF Flange | ● | ● | ● | ● | ● | ● |
| | 010R | JIS10K RF Flange | ○ | ○ | ○ | ○ | ○ | ○ |
| | 020F | JIS20K FF Flange | ○ | ○ | ○ | ○ | ○ | × |
| | 020R | JIS20K RF Flange | ○ | ○ | ○ | ○ | ○ | ○ |

※7 : The nominal size & volume symbol 50B is manufactured only a material symbol FB or F7.

※8 : The nominal size & volume symbol 50B is manufactured inner structure by CAC406.

※9 : The nominal size & volume symbol 50B is manufactured inner structure by SUS304.

※10 : SIG1 and SIG2 output of standard article are delivered with the following setting.

| | |
|------------------------------|-----------------------|
| SIG1 output : Kind of signal | Voltage no-contact |
| Electronic logic | Positive logic |
| Pulse output | Unitless pulse output |
| SIG2 output : Kind of signal | Voltage no-contact |
| Electronic logic | Positive logic |
| Pulse output | Unit pulse output |

3.3 External dimension drawing (Unit: mm)

(1) Field indication type

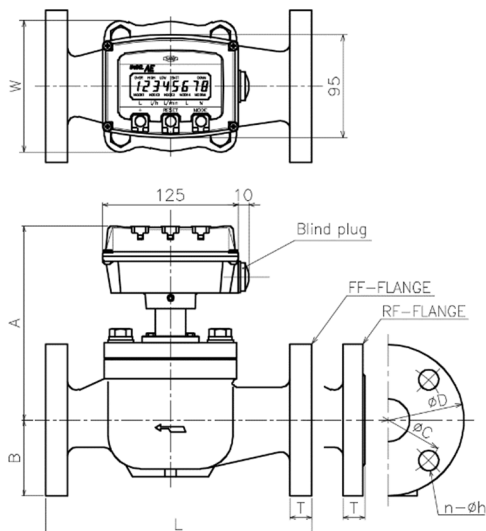

(2) Pulse, & alarm output, and analog output type

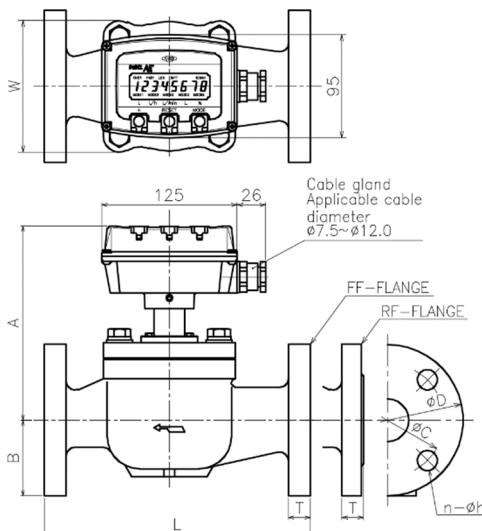

| Nominal size & volume symbol | Nominal size | Flange standard | L | A | B | W | D | T | | C | n | h | Weight (kg) |
|------------------------------|--------------|-----------------|-----|-------|------|-----|-----|-----|-----|-----|---|----|-------------|
| | | | | | | | | FCD | SCS | | | | |
| 025A0 025B0 | 25A | JIS10K | 225 | 170 | 62.5 | 98 | 125 | 20 | 16 | 90 | 4 | 19 | 8.5 |
| 040A0 040B0 | 40A | JIS10K | 245 | 179 | 70 | 122 | 140 | 20 | 18 | 105 | 4 | 19 | 11.6 |
| 050A0 | 50A | JIS10K | 245 | 179 | 77.5 | 122 | 155 | 20 | 18 | 120 | 4 | 19 | 13.3 |
| 050B0* | 50A | JIS10K | 250 | 182.5 | 77.5 | 122 | 155 | 20 | — | 120 | 4 | 19 | 14.4 |

*The nominal size & volume symbol 50B is manufactured only material symbol FB or F7.
This table of weight indicates the case of material symbol FB.

(3) Field indication type
(for high temperature specification)

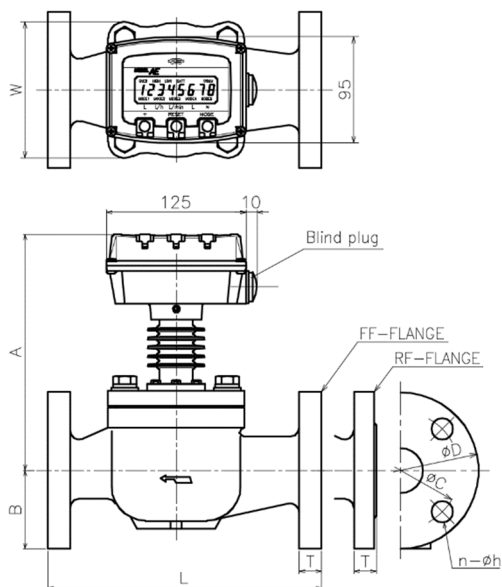

(4) Pulse, & alarm output, and analog output type
(for high temperature specification)

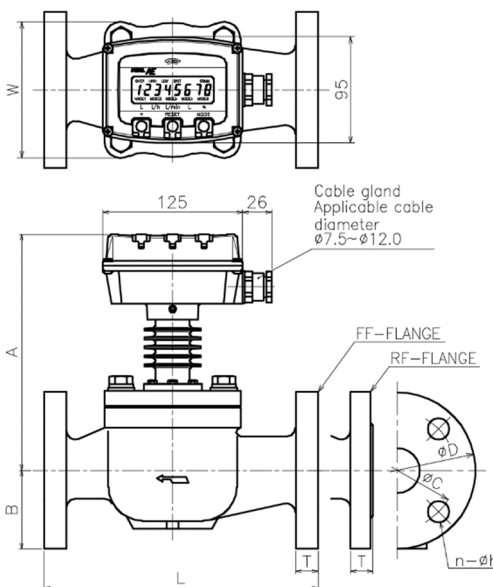

| Nominal size & volume symbol | Nominal size | Flange standard | L | A | B | W | D | T | | C | n | h | Weight (kg) |
|------------------------------|--------------|-----------------|-----|-------|------|-----|-----|-----|-----|-----|---|----|-------------|
| | | | | | | | | FCD | SCS | | | | |
| 025A0 025B0 | 25A | JIS10K | 225 | 202 | 62.5 | 98 | 125 | 20 | 16 | 90 | 4 | 19 | 8.9 |
| 040A0 040B0 | 40A | JIS10K | 245 | 211 | 70 | 122 | 140 | 20 | 18 | 105 | 4 | 19 | 12.0 |
| 050A0 | 50A | JIS10K | 245 | 211 | 77.5 | 122 | 155 | 20 | 18 | 120 | 4 | 19 | 13.7 |
| 050B0* | 50A | JIS10K | 250 | 214.5 | 77.5 | 122 | 155 | 20 | — | 120 | 4 | 19 | 14.8 |

*The nominal size & volume symbol 50B is manufactured only material symbol FB or F7.
This table of weight indicates the case of material symbol FB.

(5)Batch type

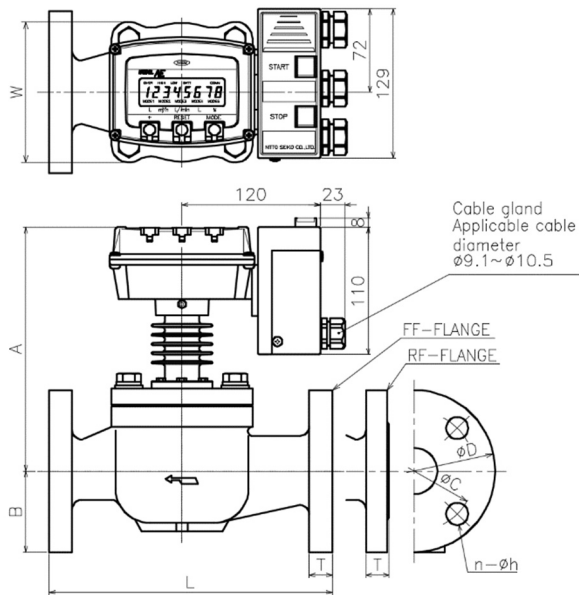

| Nominal size & volume symbol | Nominal size | Flange standard | L | A | B | W | D | T | | C | n | h | Weight (kg) |
|------------------------------|--------------|-----------------|-----|-------|------|-----|-----|-----|-----|-----|---|----|-------------|
| | | | | | | | | FCD | SCS | | | | |
| 025A0 025B0 | 25A | JIS10K | 225 | 202 | 62.5 | 98 | 125 | 20 | 16 | 90 | 4 | 19 | 9.5 |
| 040A0 040B0 | 40A | JIS10K | 245 | 211 | 70 | 122 | 140 | 20 | 18 | 105 | 4 | 19 | 12.6 |
| 050A0 | 50A | JIS10K | 245 | 211 | 77.5 | 122 | 155 | 20 | 18 | 120 | 4 | 19 | 14.3 |
| 050B0 [※] | 50A | JIS10K | 250 | 214.5 | 77.5 | 122 | 155 | 20 | — | 120 | 4 | 19 | 15.4 |

※The nominal size & volume symbol 50B is manufactured only material symbol FB or F7.
This table of weight indicates the case of material symbol FB.

4. Installation

4.1 Piping design

Take account of the following points in the piping design to enable correct measurement:

- (1) Place of mounting
 - Place easy for inspection.
 - Place protected against direct sunshine.
 - Place not subject to rain or dew drops.
 - Place with little corrosive gas.
 - Place with little dust.
 - Place with little electromagnetic noise.
 - Place with little vibrations of piping and fluid.
- (2) Prevention of noise

Select a place not close to any power source such as motor, transformer, etc. as it may cause noise interference to the flow meter.
- (3) Service area

A service area is required for such works as mounting, wiring, inspection, etc. Select a place where a sufficient space can be secured for it.
- (4) Mounting posture

Perform piping design so that the liquid may always be filled with inside the measuring unit of the flow meter.

4.2 Mounting

4.2.1 Mounting precautions

- (1) The flow meter is firmly packed. Take good care not to damage the equipment at the time of unpacking. Moreover, to prevent damage due to accident during transportation to the place of installation, carry near the place of installation in the state packed as it was delivered.
- (2) Take care not to drop or add any excessive impact.
- (3) Make the flow direction of measured liquid being match to arrow mark on the measuring part of flow meter. When installing on a vertical piping, mount in such a way that the fluid flows from bottom to up as much as possible.
- (4) It is undesirable to leave the flow meter in the state of non use for a long time after installation. Take the following protective measures when you leave it out of use for some inevitable reason:
 - * Check sealed state of equipment.
Make sure that the screws of counting unit case, wire connecting port, etc. are sealed completely.
 - * Perform periodical inspection.
Inspect the above items and the state inside the counting unit case at least once a year. Moreover, inspect at any occasion when there is any fear of penetration of water in the flow meter because of rainfall, etc.
- (5) Tighten the flange bolts evenly.

4.2.2 Precautions regarding the piping

- (1) Be sure to install the strainer on the inlet side of the Electronic Positive Displacement Flow Meter "Flow Eye" (Type: FE3E), Electronic Flow Meter for Small Flow Rate "Nico Eye" (NE3E), and Electronic Flow Meter for Small Flow Rate "Oil Eye" (Type OE3E).
Standard mesh of filter are as below.
Flow Eye and Oil Eye :60 mesh
Nico Eye :200 mesh.

Electronic Flow Meter for Water Supply "Aqua Eye" has built-in strainer. To avoid inflow and mixing of broken pieces of internal component parts, install a strainer also on the outlet side of any flow meter as required.

- (2) The flow meter shall be installed on the outlet side of the pump. When using with a tank head, provide a head (pressure) larger than the sum of the pressure loss of strainer and that of flow meter.
- (3) Install a bypass piping. Piping is taken account of the measuring part protection from flushing at initial operation or air discharge as well as be taken account of inspection and maintenance.
- (4) Perform piping installation by securing necessary space for inspection, disassembling, etc. of the flow meter. Especially, secure a space for enabling disassembling of the measuring unit of the flow meter.
- (5) To avoid giving piping stress to the flow meter, install in a way not to be deviated from the center of the piping.
- (6) When using liquid packing and seal tape, etc. at the time of piping installation, take good care to prevent the tape, etc. from protruding into the piping.
- (7) In the case where the pump is of plunger type or diaphragm type and that the suction side is engine cylinder, pulsating flow is produced in the liquid, causing damage to the rotor or instrumental error. At that time, eliminate the pulsating flow completely by installing an air chamber or accumulator on the pump producing the pulsating flow or on the engine cylinder side.

4.2.3 Checking adjacent pipe

- (1) In case the piping is either inclined or eccentric or if the face-to-face dimension is out of the tolerance value, be sure to correct the irregularity before installing the flow meter.
- (2) Foreign matters such as weld refuse or wood chip, etc. may be sometimes found in newly installed pipeline. Remove foreign matters by flushing, etc. before installing the flow meter.

4.2.4 Precautions regarding execution of heat preservation work



For any liquid of properties freezing or solidifying in the piping or liquid of specifications requiring heat preservation, execute heat insulation work for the flow meter, strainer and piping.

- (1) Before executing the heat insulation work, check for any leakage of liquid.
- (2) For the flow meter and strainer, execute heat insulation by a method enabling easy maintenance, inspection and disassembling. Moreover, take care not to spoil the safety of handling by hiding specifications and precautions of the flow meter such as name plate, caution plate with the work.
- (3) Avoid performing heat preservation for the counting unit.

4.2.5 Precautions regarding outdoor installation

The ambient temperature of the counting unit is $-10 \sim 60^{\circ}\text{C}$. In a place exposed to rain water or direct sunshine, provide a guard such as rain protector or shade, etc. on the counting unit. Especially for use in a place where salt damage is expected, take protective measures against salt damage.

4.2.6 Change of reading direction

Please loosen the hexagonal socket head bolt (M4 × 0.7) on the side of the counting part by rotating it more than 3 times with a hexagonal wrench (width across flat : 3 mm). Next, turn the counting part in an arbitrary direction. Then fasten the counting part by tightening the hexagon socket head bolt.



5. Wiring and setting of printed circuit board

Connect the external signal wire of the flow meter to the terminal block inside the counting unit.
The output printed circuit board varies depending on the type of counting unit and the wiring is also variable.

5.1 Output printed circuit board

5.1.1 Pulse & alarm output type

(1) Output printed circuit board

When remove the screw at 4 corners of the counting unit and open it, the output printed circuit board appears under the battery.

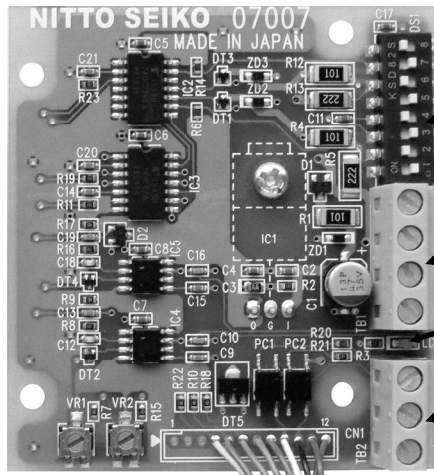
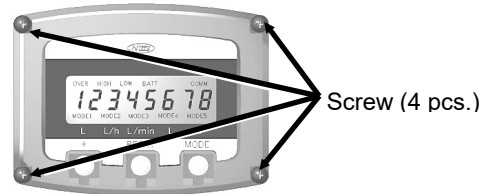

① Signal type setting switch

② Terminal block for connecting pulse & alarm output

③ External power supply LED

④ Terminal block for connecting to printed circuit board for batch

① **Signal type setting switch (DS1)**

Sets the signal type of SIG1, SIG2 and the range of VR1, VR2.

② **Terminal block for connecting pulse & alarm output (TB1)**

This is a terminal block for connecting external power supply, SIG1 signal and SIG2 signal.

③ **External power supply LED (LD1)**

Lights when external power is supplied.

④ **Terminal block for connecting to printed circuit board for batch (TB2)**

This is a terminal block for connecting to printed circuit board for batch.

(2) Contents of setting

● Type of signal of SIG1

| Contents of setting of DS1 | Type of signal (Electronic logic) |
|-----------------------------------------------------------------------------------------------------------|-------------------------------------|
| ON <input type="checkbox"/> 1 <input checked="" type="checkbox"/> 2 <input type="checkbox"/> 3 | Voltage no-contact (Positive logic) |
| ON <input checked="" type="checkbox"/> 1 <input type="checkbox"/> 2 <input type="checkbox"/> 3 | Voltage no-contact (Negative logic) |
| ON <input checked="" type="checkbox"/> 1 <input checked="" type="checkbox"/> 2 <input type="checkbox"/> 3 | Open collector (Positive logic) |
| ON <input checked="" type="checkbox"/> 1 <input type="checkbox"/> 2 <input checked="" type="checkbox"/> 3 | Open collector (Negative logic) |

● Type of signal of SIG2

| Contents of setting of DS1 | Type of signal (Electronic logic) |
|-----------------------------------------------------------------------------------------------------------|-------------------------------------|
| ON <input type="checkbox"/> 5 <input checked="" type="checkbox"/> 6 <input type="checkbox"/> 7 | Voltage no-contact (Positive logic) |
| ON <input checked="" type="checkbox"/> 5 <input type="checkbox"/> 6 <input type="checkbox"/> 7 | Voltage no-contact (Negative logic) |
| ON <input checked="" type="checkbox"/> 5 <input checked="" type="checkbox"/> 6 <input type="checkbox"/> 7 | Open collector (Positive logic) |
| ON <input checked="" type="checkbox"/> 5 <input type="checkbox"/> 6 <input checked="" type="checkbox"/> 7 | Open collector (Negative logic) |

5.1.2 Analog output type

(1) Output printed circuit board

When remove the screw at 4 corners of the counting unit and open it, the output printed circuit board appears under the battery.

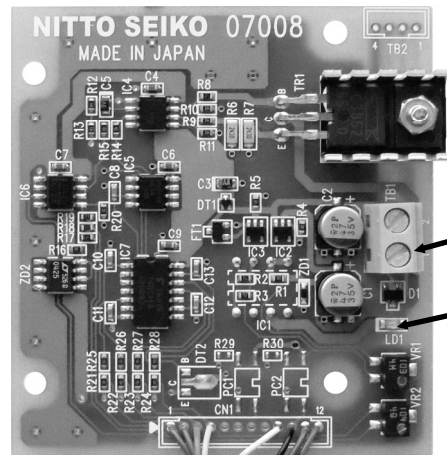
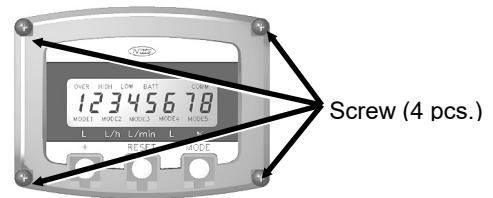

① Terminal block for connecting analog output

② External power supply LED

① Terminal block for connecting analog output (TB1)

This is a terminal block for connecting external power supply and analog signal.

② External power supply LED (LD1)

Lights when external supply is supplied.

5.1.3 Batch type

⚠ Electronic Flow Meter for Small Flow Rate "Nico Eye" (Type: NE3E) does not have batch type.

(1) Output printed circuit board

When remove the screw at 4 corners of the counting unit and open it, the output printed circuit board appears.

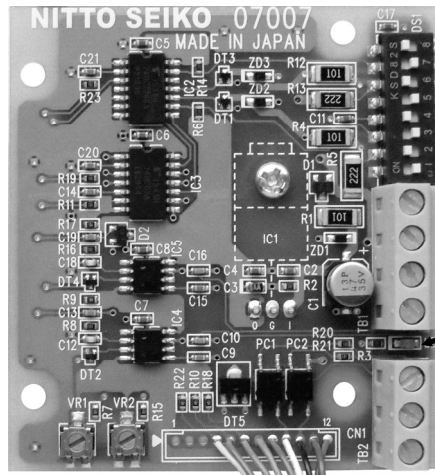
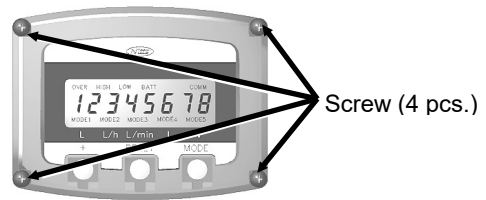

① Signal type setting switch

② Terminal block for connecting pulse & alarm output

③ External power supply LED

④ Terminal block for connecting to printed circuit board for batch

① Signal type setting switch (DS1)

Sets the signal type of SIG1, SIG2 and the range of VR1, VR2.

③ External power supply LED (LD1)

Lights when external power is supplied.

② Terminal block for connecting pulse & alarm output (TB1)

This is a terminal block for connecting external power supply, sig1 signal and sig2 signal. In case of batch type it is connected to printed circuit board for batch.

④ Terminal block for connecting to printed circuit board for batch (TB2)

This is a terminal block for connecting to printed circuit board for batch.

(2) Contents of setting

● Type of signal of SIG1

| Contents of setting of DS1 | Type of signal (Electronic logic) |
|--------------------------------------------------------------------------------------------------------------|-------------------------------------|
| ON <input checked="" type="checkbox"/> <input type="checkbox"/> <input type="checkbox"/> 1 2 3 | Voltage no-contact (Positive logic) |
| ON <input type="checkbox"/> <input checked="" type="checkbox"/> <input type="checkbox"/> 1 2 3 | Voltage no-contact (Negative logic) |
| ON <input checked="" type="checkbox"/> <input checked="" type="checkbox"/> <input type="checkbox"/> 1 2 3 | Open collector (Positive logic) |
| ON <input checked="" type="checkbox"/> <input type="checkbox"/> <input checked="" type="checkbox"/> 1 2 3 | Open collector (Negative logic) |

● Type of signal of SIG2

| Contents of setting of DS1 | Type of signal (Electronic logic) |
|--------------------------------------------------------------------------------------------------------------|-------------------------------------|
| ON <input checked="" type="checkbox"/> <input type="checkbox"/> <input type="checkbox"/> 5 6 7 | Voltage no-contact (Positive logic) |
| ON <input type="checkbox"/> <input checked="" type="checkbox"/> <input type="checkbox"/> 5 6 7 | Voltage no-contact (Negative logic) |
| ON <input checked="" type="checkbox"/> <input checked="" type="checkbox"/> <input type="checkbox"/> 5 6 7 | Open collector (Positive logic) |
| ON <input checked="" type="checkbox"/> <input type="checkbox"/> <input checked="" type="checkbox"/> 5 6 7 | Open collector (Negative logic) |

(3) Batch printed circuit board

When remove the screw on the lateral face of the counting unit and open the lid, the batch printed circuit board appears.

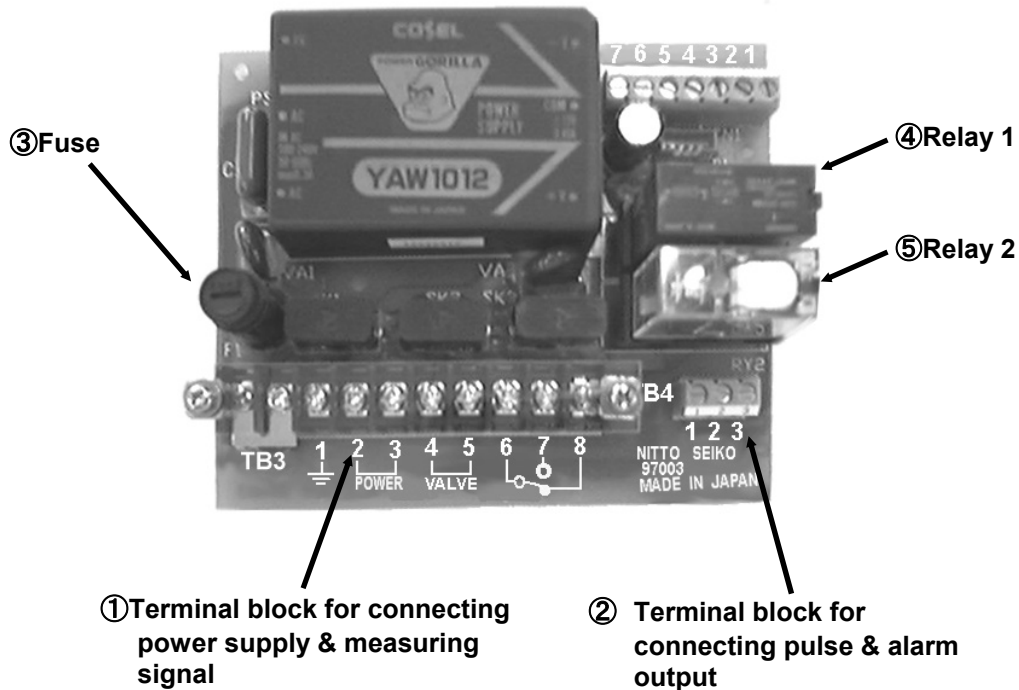
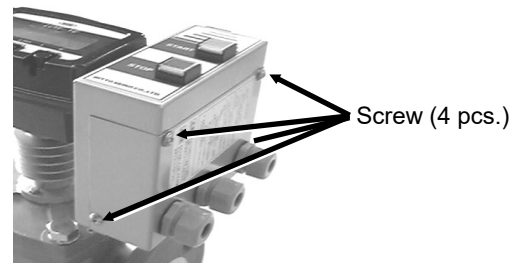

Note) The photo shows a unit of AC specification.

① **Terminal block for connecting power supply & measuring signal (TB3)**
This is a terminal block for connecting power supply & measuring signal.

② **Terminal block for connecting pulse & alarm output (TB4)**
This is a terminal block for connecting SIG1 and SIG2 signals.

③ **Fuse (F)**
This is a fuse for power supply.

④ **Relay 1 (RY1)**
This is a relay for the measuring signal 1.

⑤ **Relay 2 (RY2)**
This is a relay for the measuring signal 2.

5.2 Precautions regarding wiring

Take the following precautions for the wiring:

- (1) Be sure to cut off external power supply before executing the wiring work.
- (2) To secure insulation and prevent trouble due to dew condensation inside the counting unit, avoid connecting cables outdoors on rainy day.
- (3) Remove the covering of the wire by 6 mm at the terminal and connect securely. However, please use crimp type terminal for the earth ground, the power supply, and the measuring signal for batch type.
- (4) Conduit wiring is recommended for the wiring. For conduit wiring of pulse & alarm output type and analog output type, use thick steel pipe 16 (JIS C 8305) . (The cable gland for batch type is not adapted to conduit wiring.)
- (5) For the wiring at the wiring port of the counting unit, keep waterproofing by sufficiently tightening the gland nut.

5.3 Power line and signal I/O line

5.3.1 Pulse & alarm output type, analog output type

| | | | | |
|-----------------------------|---|---------------------------|---------------|-----------------------------|
| Cable | : | Use shielded cable. | | |
| Cable specifications | : | Finished outside diameter | 7.5 ~ 12.0 mm | |
| | | Nominal sectional area | Stranded wire | : 0.5 ~ 1.5 mm ² |
| | | or diameter | Simple wire | : 0.9 ~ 1.5 mm |

5.3.2 Batch type

· Pulse & alarm output part

| | | | | |
|-----------------------------|---|---------------------------|---------------|-----------------------------|
| Cable | : | Use shielded cable. | | |
| Cable specifications | : | Finished outside diameter | 9.1 ~ 10.5 mm | |
| | | Nominal sectional area | Stranded wire | : 0.5 ~ 1.5 mm ² |
| | | or diameter | Simple wire | : 0.9 ~ 1.5 mm |

· Earth ground, power supply, measuring signal part

| | | | | |
|-----------------------------|---|---------------------------|---------------|------------------------------|
| Cable | : | Use shielded cable. | | |
| Cable specifications | : | Finished outside diameter | 9.1 ~ 10.5 mm | |
| | | Nominal sectional area | Stranded wire | : 1.25 ~ 2.0 mm ² |

5.4 Termination of cable

In the termination of cable, take care so that the portion deprived of outer sheath does not reach the packing seal.

5.5 Wiring port

This instrument is provided with a cable gland at the wiring port. To avoid trouble due to unexpected penetration of water, be sure to use the attached cable gland for the signal wiring port.

The pulse & alarm output type and the analog output type have a waterproof construction stipulated in JIS C 0920-1993 "Waterproofing Tests of Electric Machinery & Equipment and protection grade against penetration of solid matters".

5.6 Earth ground terminal

Earth ground terminal is provided on the right figure inside the counting part case. (Screw M3)

Earth ground terminal



For the batch type ground connection, use the ground terminal of the Terminal block (TB3) of the batch printed circuit board.



Caution

At the time of wiring, make sure that following items are provided in the cable gland without fail.

Pulse & alarm output type, analog output type : Washer, packing

Batch type : Packing



Caution

When performing conduit wiring, attach a cable gland to the wire connecting port and incline the conduit piping to prevent water from flowing into the wiring port through the conduit. Moreover, provide a drain valve at the rise part of the conduit piping and discharge drain regularly.

5.7 Connection

5.7.1 Connection of pulse & alarm output type

(1) Voltage no-contact output

Perform wiring by paying attention to voltage and polarity.

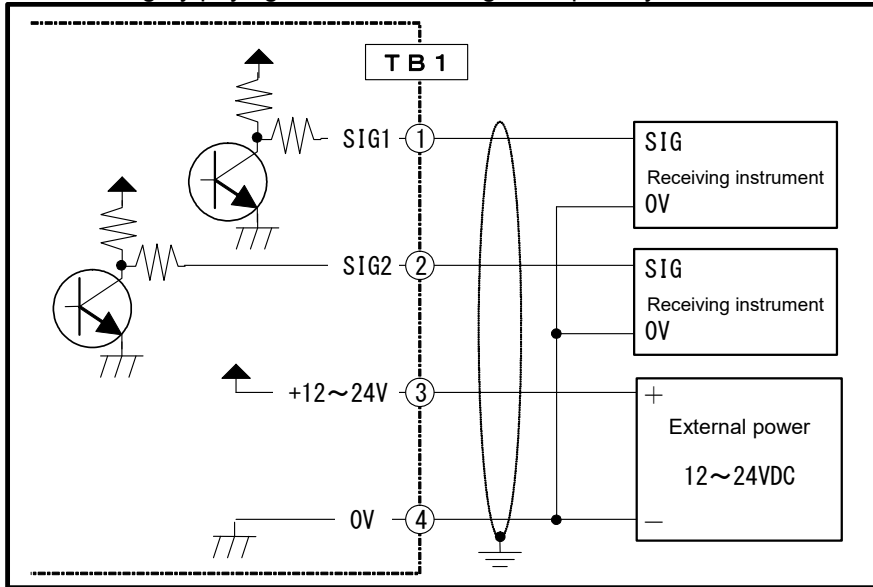

(2) Open collector output

Perform wiring by paying attention to voltage and polarity.

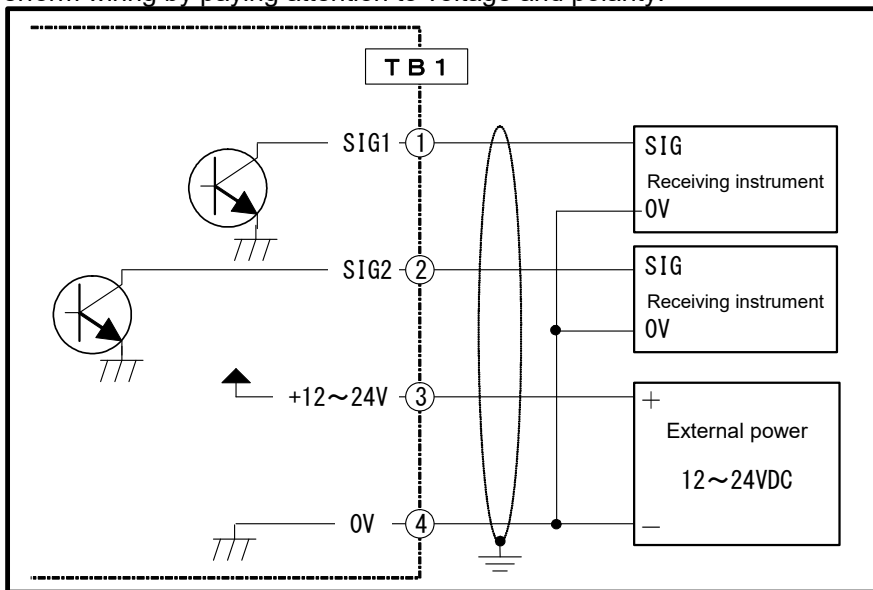

5.7.2 Connection of analog output type

Perform wiring by paying attention to voltage and polarity.

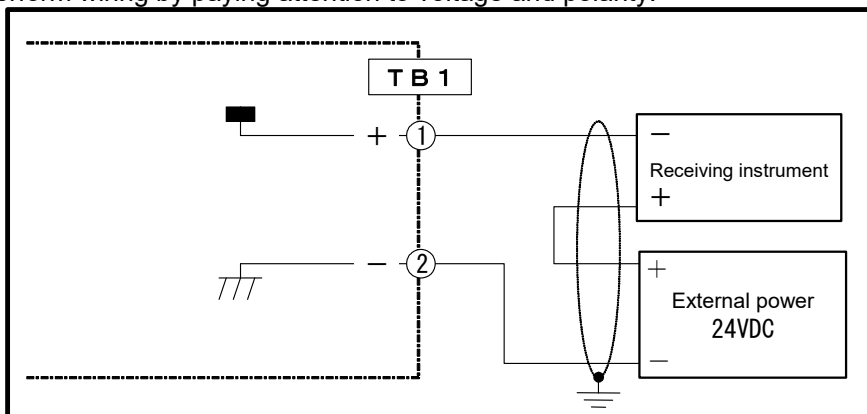

5.7.3 Connection of batch type

5.7.3.1 Connection of pulse & alarm output unit

(1) Voltage no-contact output

Perform wiring by paying attention to voltage and polarity.

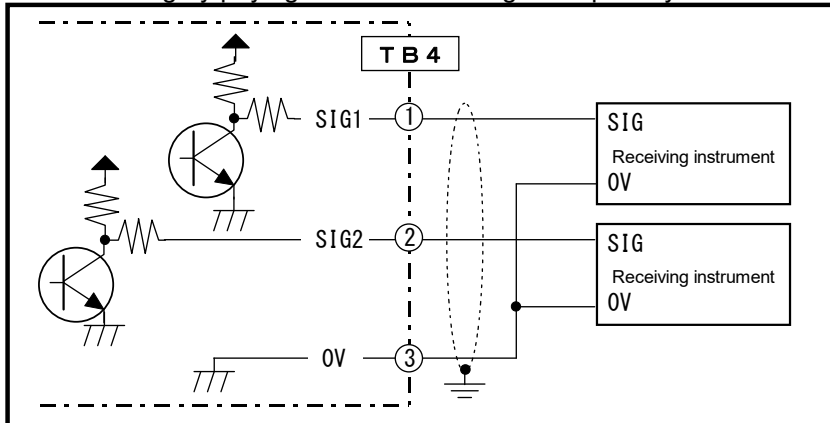

(2) Open collector output

Perform wiring by paying attention to voltage and polarity.

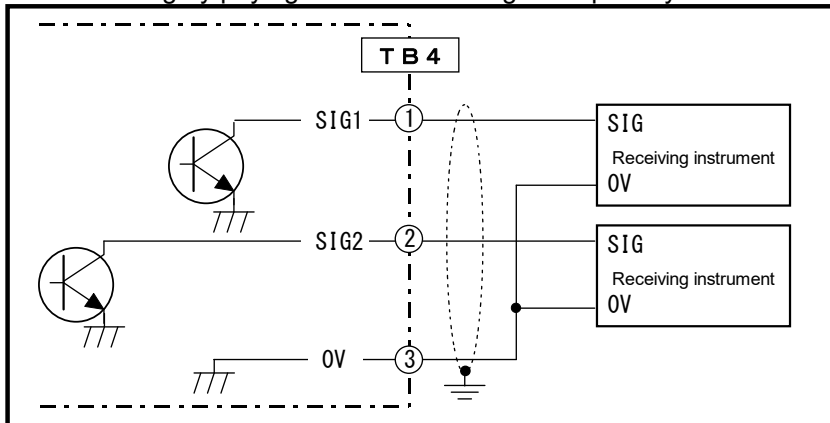

5.7.3.2 Wiring of power supply & measuring signal unit

(1) AC specification

Perform wiring by paying attention to voltage.

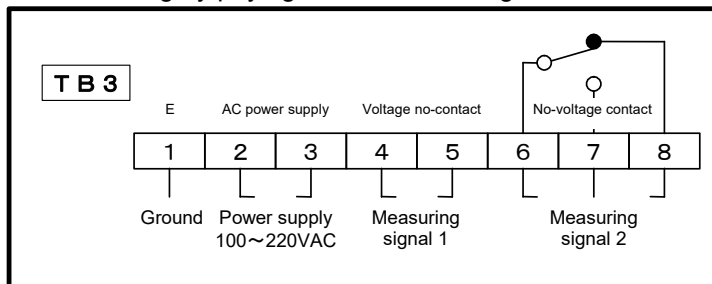

(2) 24V DC specification

Perform wiring by paying attention to voltage and polarity.

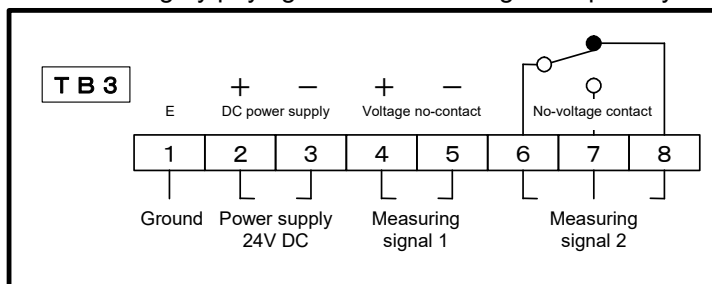

6. Basic operations

6.1 Field indication type, Pulse & alarm output type, and Analog output type

6.1.1 Liquid crystal display / component and function of buttons

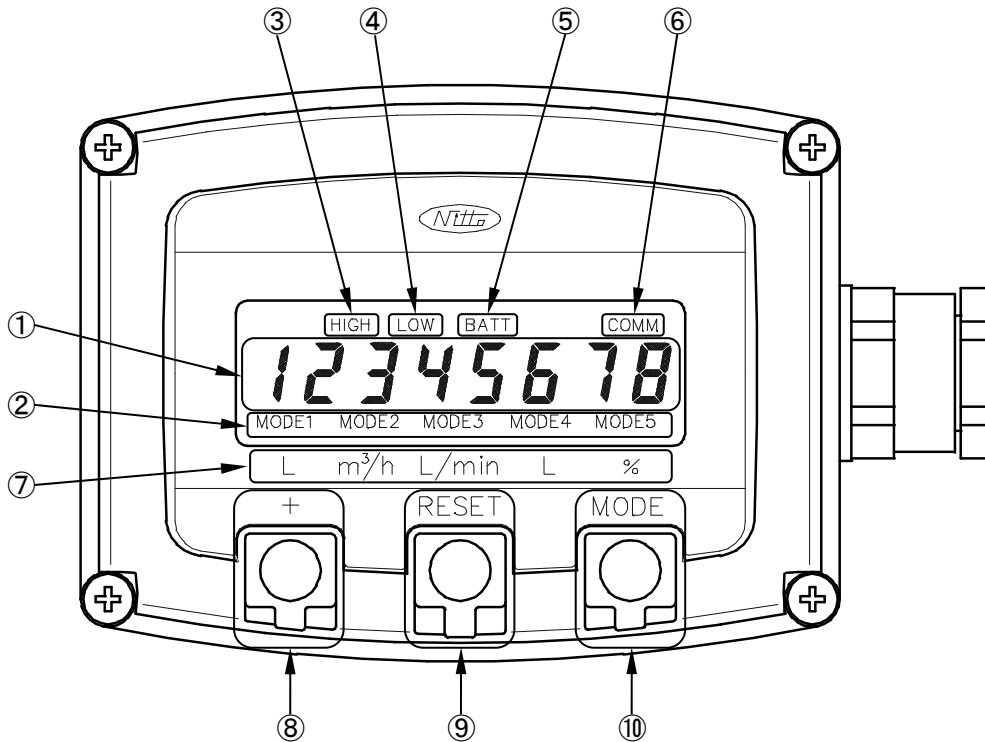

- ① **Segment indication :**
Indicates integrated value, momentary flow rate, etc.
- ② **Mode indication :**
Indicates currently displayed mode.
MODE 1 : Integrated flow value (Non resettable)
MODE 2 : Momentary flow rate (/h)
MODE 3 : Momentary flow rate (/min)
MODE 4 : Integrated flow value (Resettable)
MODE 5 : Momentary flow rate (%)
- ③ **Upper limit flow rate alarm indication (HIGH) :**
Lights in case the momentary flow rate exceeded the upper limit flow rate alarm value.
- ④ **Lower limit flow rate alarm indication (LOW) :**
Lights in case the momentary flow rate dropped to below the lower limit flow rate alarm value.
- ⑤ **Battery alarm indication (BATT) :**
Lights when the residual capacity of the internal battery becomes few. (Only with battery)
- ⑥ **External power supply indication (COMM) :**
Lights when external power is supplied.
- ⑦ **Unit nameplate :**
Indicates the unit in each mode.
- ⑧ **+ Button :**
Not used. (Used in setting mode)
- ⑨ **RESET button :**
Puts the integrated flow value (resettable) to zero.
- ⑩ **MODE button :**
Switches the displayed mode.

6.1.2 Switching of Integrated flow value and Momentary flow rate display

| Contents of indication | Contents of operation |
|-------------------------------------------------------------------------------------------------------------------------------------------------------------------------------------------------------------------------------------------------------------------------------------------------------------------------------------------------------------------------------------------------------------------------------------------------------------------------------------------------------------------------------------------------------------------------------------------------------------------------------------------------------------------------------------------------------------------------------------------------------------|------------------------------------------------------------------------------------------------------------------------------------------------------------------------------------------------------------------------------------------------------------------------------------------------------------------------------------------------------------------------------------------------------------------------------------------------------------------------------------------------------------------------------------------------------------------------------------------------------------------------------------------------------------------------------------------------------------------------------------------------------------------------------------------------------------------------------------------------------------------------------------------------------------------------------------------------------------------------------------------------------------------------------------------------------------------------------|
| <p>The diagram illustrates the following sequence of display modes and transitions:</p> <ul style="list-style-type: none"> MODE1: Displays '123456.78'. Pressing [MODE] (left) or [MODE] (right) leads to MODE2. MODE2: Displays '2.40'. Pressing [MODE] (right) leads to MODE3. MODE3: Displays '40.0'. Pressing [MODE] (left) or [MODE] (right) leads to MODE4. MODE4: Displays '12345'. Pressing [RESET] (right) leads to a sub-mode of MODE4. MODE4 (sub-mode): Displays '000'. Pressing [MODE] (left) leads to MODE5. MODE5: Displays '800'. Pressing [MODE] (left) leads back to MODE1. | <ul style="list-style-type: none"> ● When press the [MODE] button while displaying Integrated flow value (MODE 1), the display switches to Momentary flow rate (/ h) (MODE 2) or Momentary flow rate (/ min) (MODE 3). ● When press the [MODE] button while displaying Momentary flow rate (/ h) (MODE 2), the display switches to Integrated flow value (Resettable) (MODE 4). ● When press the [MODE] button while displaying Momentary flow rate (/ min) (MODE 3), the display switches to Integrated flow value (Resettable) (MODE 4). ● When press the [RESET] button while displaying Integrated flow value (MODE 4), reset the value of Integrated flow value (resettable) to 0. ● When press the [MODE] button while displaying Integrated flow value (MODE 4), the display switches to Momentary flow rate (%) (MODE 5). ● When press the [MODE] button while displaying Momentary flow rate (%) (MODE 5), display switches to Integrated flow value (MODE 1) |

Note 1) Display switching of Momentary flow rate (/ h) and Momentary flow rate (/ min) is set by data setting item "b1: switching of Momentary flow rate". (Standard: Momentary flow rate (/ h) display)

6.2 Batch type

⚠ Electronic Flow Meter for Small Flow Rate "Nico Eye" (Type: NE3E) does not have batch type.

6.2.1 Liquid crystal display / component and function of buttons

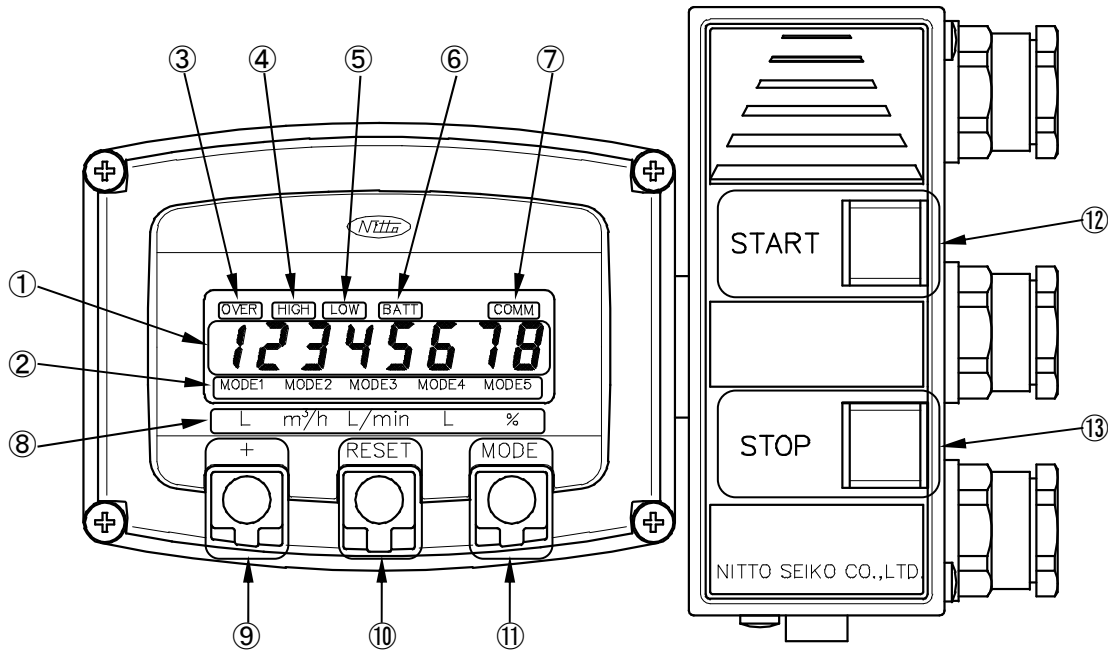

① **Segment indication :**

Indicates integrated value, momentary flow rate, etc.

② **Mode indication :**

Indicates currently displayed mode.
 MODE 1 : Integrated flow value (Non resettable)
 MODE 2 : Momentary flow rate (/h)
 MODE 3 : Momentary flow rate (/min)
 MODE 4 : Batch counter
 MODE 5 : Momentary flow rate (%)

③ **Batch over indication (OVER) :**

Lights when exceeded the batch volume.

④ **Upper limit flow rate alarm indication (HIGH) :**

Lights in case the momentary flow rate exceeded the upper limit flow rate alarm value.

⑤ **Lower limit alarm indication (LOW) :**

Lights in case the momentary flow rate dropped to below the lower limit flow rate alarm value.

⑥ **Battery alarm indication (BATT) :**

Lights when the residual capacity of the internal battery becomes few. (Only with battery)

⑦ **External power supply indication (COMM) :**

Lights when external power is supplied.

⑧ **Unit nameplate :**

Indicates the unit in each mode.

⑨ **+ Button :**

Not used. (Used in setting mode)

⑩ **RESET button :**

Resets the batch counter to the initial value.

⑪ **MODE button**

Switches the displayed mode.

⑫ **START button**

Starts or resumes batch operation.

⑬ **STOP button**

Stops batch operation.

6.2.2 Integrated flow value (non-resettable), batch volume, momentary flow rate

| Contents of indication | Contents of operation |
|------------------------------------------------------------------------------------------------------------------------------------------------------------------------------------------------------------------------------------------------------------------------------------------------------------------------------------------------------------------------------------------------------------------------------------------------------------------------------------------------------------------------------------------------------------------------------------------------------------------------|----------------------------------------------------------------------------------------------------------------------------------------------------------------------------------------------------------------------------------------------------------------------------------------------------------------------------------------------------------------------------------------------------------------------------------------------------------------------------------------------------------------------------------------------------------------------------------------------------------------------------------------------------------------------------------------------------------------------------------------------------------------------------------------------------------------------------------------------------------------------------------------------------------------------------------------------------------------------------------------------------------|
| <p>The diagram illustrates the sequence of display modes for the flow meter. It starts with MODE1 showing an integrated flow value of 123456.78. Pressing the [MODE] button switches to MODE2 (2.40), which is the momentary flow rate (/h). Pressing [MODE] again switches to MODE3 (400), the momentary flow rate (/min). Pressing [MODE] a third time switches to MODE4 (bt 123.45), the batch counter. Pressing [MODE] a fourth time switches to MODE5 (800), the momentary flow rate (%). Pressing [RESET] in MODE4 resets the batch counter to 50000. Pressing [MODE] in MODE5 returns the display to MODE1.</p> | <ul style="list-style-type: none"> ● Displays integrated flow value (non-resettable) (MODE 1). When press the [MODE] button, the indication is switched to momentary flow rate (/h) (MODE 2) or momentary flow rate (/min) (MODE 3). ● Displays momentary flow rate (/h) (MODE 2). Note 1) When press the [MODE] button, the indication is switched to batch counter (MODE 4). ● Displays momentary flow rate (/min) (MODE 3). Note 1) When press the [MODE] button, the indication is switched to batch counter (MODE 4). ● Displays batch counter (MODE 4). When press the [MODE] button, the indication is switched to momentary flow rate (%) (MODE 5). When press the [RESET] button, the batch counter value is reset to the initial value. ● Displays momentary flow rate (%) (MODE 5). When press the [MODE] button, the indication is switched to integrated flow value (non-resettable) (MODE 1). |

Note 1) Display switching of Momentary flow rate (/ h) and Momentary flow rate (/ min) is set by data setting item "b1: switching of Momentary flow rate". (Standard: Momentary flow rate (/ h) display)

6.2.3 Change of batch amount

| Contents of indication | Contents of operation |
|-----------------------------------------------------------------------------------------------------------------------------------------------------------------------------------------------------------------------------------------------------------------------------------------------------------------------------------------------------------------------------------------------------------------------------------------------------------------------------------------------------------------------------------------------------------------------------------------------------------------------------------------------------------------------------------------------------------|---------------------------------------------------------------------------------------------------------------------------------------------------------------------------------------------------------------------------------------------------------------------------------------------------------------------------------------------------------------------------------------------------------------------------------------------------------------------------------------------------------------------------------------------------------------------------------------------------------------------------------------------------------------------------------------------------------------------------------------------------------------------------------------------------------------------------------------------------------------------------------------|
| <p>The diagram illustrates the process of changing the batch amount through several steps:</p> <ul style="list-style-type: none"> Initial state: Display shows bt 123456 in MODE4. Step 1: Pressing [H] and [RESET] changes the display to bt 12345 with a small icon. Step 2: Pressing [H] changes the display to bt 12345 with a different icon. Step 3: Pressing [RESET] changes the display to bt 123457. Step 4: Pressing [H] changes the display to bt 123457 with a third icon. Step 5: Pressing [MODE] changes the display to bt 123467 in MODE4. | <ul style="list-style-type: none"> ● Press the [RESET] button while pressing the [+] button during an indication of the batch counter (MODE 4). <p style="text-align: center;"><u>Note) No change can be made during a measurement or a stop (all displayed digits are blinking).</u></p> <ul style="list-style-type: none"> ● Display is switched to batch volume setting mode. (Starts blinking.) ● Change the batch volume by the [+] and [RESET] buttons. <ol style="list-style-type: none"> When press the [+] button, the blinking digit number increases by 1. When press the [RESET] button, the blinking digit moves. ● When press the [MODE] button, the batch volume setting mode is terminated. (The modified batch volume is set.) |

6.2.4 Actions

● Counting system

- Overshoot no-count system

The counter starts counting (starts subtraction on the batch counter) with a start of measurement (pressing the **[START] button**), and stops counting when 0 is reached on the batch counter. It is also available stop counting by pressing **[STOP] button** or **[RESET] button**.

- Overshoot count system

The counter starts counting (starts subtraction on the batch counter) with a start of measurement (pressing the **[START] button**), and stops counting with pressing of the **[RESET] button**. However, if the liquid is flowing when the batch counter comes to zero or when a STOP operation is made, the counting is continued (indicates "OVER" and adds the value when the indicated value comes to under zero) according to the liquid flow.

● Resetting system

- Automatic reset system

Automatically resets (returns to batch volume) when the batch counter comes to zero.

- Manual reset system

No resetting though the batch counter comes to zero. Resets with pressing of the **[RESET] button**.

● Overshoot correcting value

- Case where counting is made by overshoot count system and that resetting is made by manual reset system

An overshoot is produced because of delayed response of valve, etc. This amount of overshoot (count value) is set for the overshoot correcting value. (The unit of overshoot correcting value is the same as that of the batch counter.)

● Metering signal

- Case where overshoot correcting value is 0

This signal is turned ON with start of measurement (pressing of **[START] button**), and turned OFF when zero is reached on the batch counter. It is also turned OFF with pressing of either the **[STOP] button** or **[RESET] button**.

- Case where overshoot correcting value is other than 0

This signal is turned ON with start of measurement (pressing of **[START] button**), and turned OFF when the indication on the batch counter and the overshoot correcting value (count value) become equal to each other. It is also turned OFF with pressing of either the **[STOP] button** or **[RESET] button**.

Note) This signal is effective in the case where the counting is made by overshoot count system and that resetting is made by manual reset system.

● Case of power failure during measurement

In case of occurrence of a power failure during a measurement, the metering signal is turned OFF and it is not turned ON though the power supply is resumed. The counter does not make counting. The state before power failure is restored with pressing of the **[START] button**.



In the case where you connect a solenoid valve to the flow meter, the response of the solenoid valve is rather slow with a nominal diameter of 40 or over and the actual volume may become larger compared with the set value of batch volume on some occasions. Use solenoid valve of a nominal diameter no larger than 25 mm. When install a solenoid valve of a nominal diameter 40 mm or over, use the flow meter with the overshoot count system.

6.2.5 Operation

● Setting the batch volume

- (1) Press the **[RESET]** and **[+] buttons** simultaneously.
- (2) Press the **[RESET]** button to move the blinking digit to the position desired to change.
- (3) Change the contents of blinking digit by pressing the **[+] button**.
- (4) Press the **[MODE] button** and set the value.

※For the details, refer to the paragraph "Changing the batch volume".

● Measuring operation

- (1) The measurement starts with pressing the **[START] button** and the counter value decreases.
- (2) The measurement stops when 0 is reached on the counter.
 - Case of automatic reset system
When the counter comes to 0, the batch volume returns to the set value automatically.
 - Case of manual reset system
The batch volume does not return to the set value though the counter comes to 0.
- (3) The batch volume returns to the set value with pressing of the **[RESET] button**.
- (4) Press the **[STOP] button** to stop the measurement.
- (5) Press the **[RESET] button** to end the measurement.

※When starting measurement, press the **[START] button** while the batch counter (MODE 4) is displayed. Starting is impossible during indication of integrated flow value (non-resettable) (MODE 1), momentary flow rate (MODE 2) or (MODE 3) or momentary flow rate (%) (MODE 5).

Time chart (Case of overshoot count system)

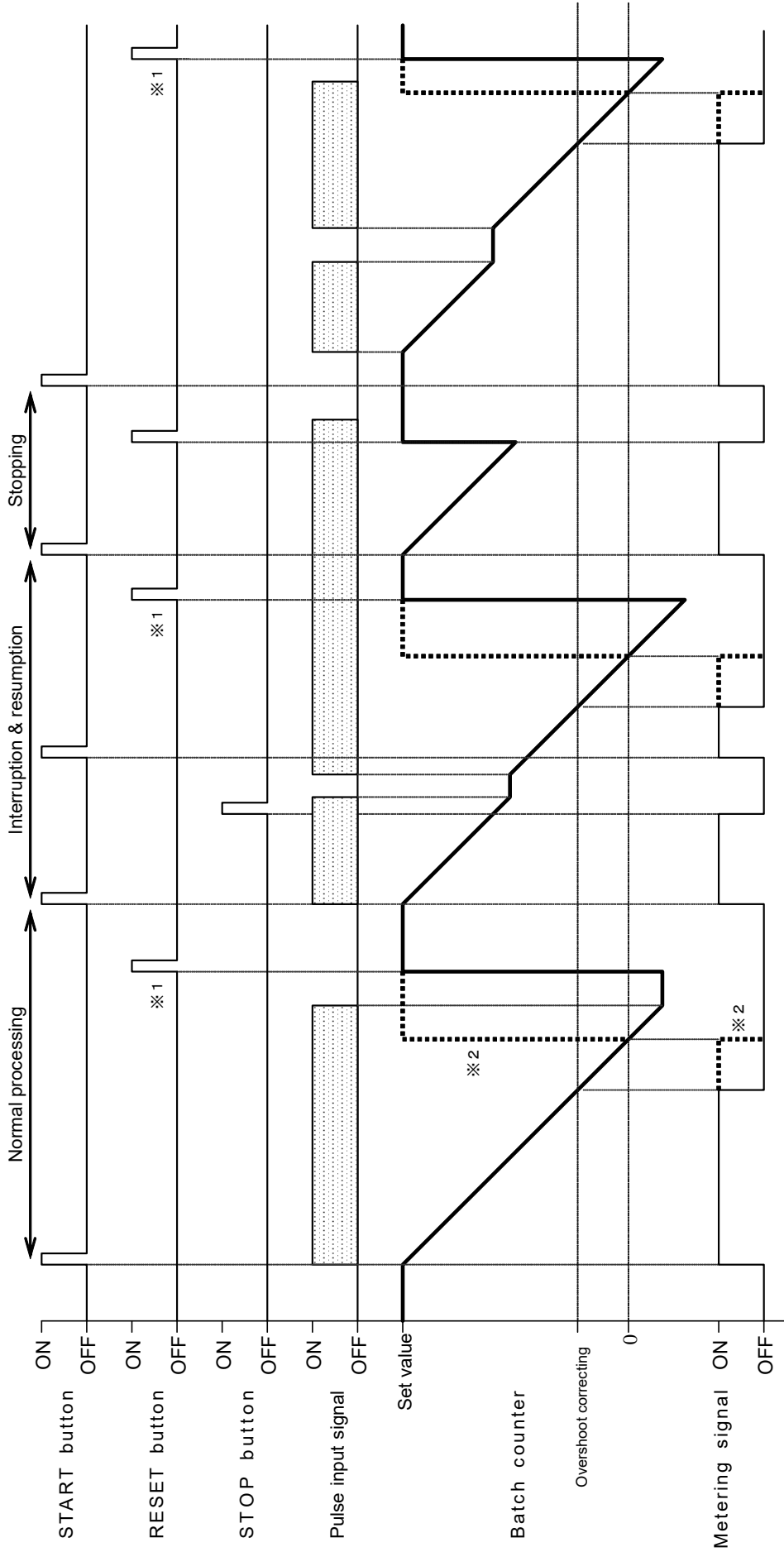

※ 1 : There is no need of resetting in the case of automatic reset system with no change to the set value.

※ 2 : " " indicates a case of automatic reset system.

Time chart (Case of overshoot no-count system)

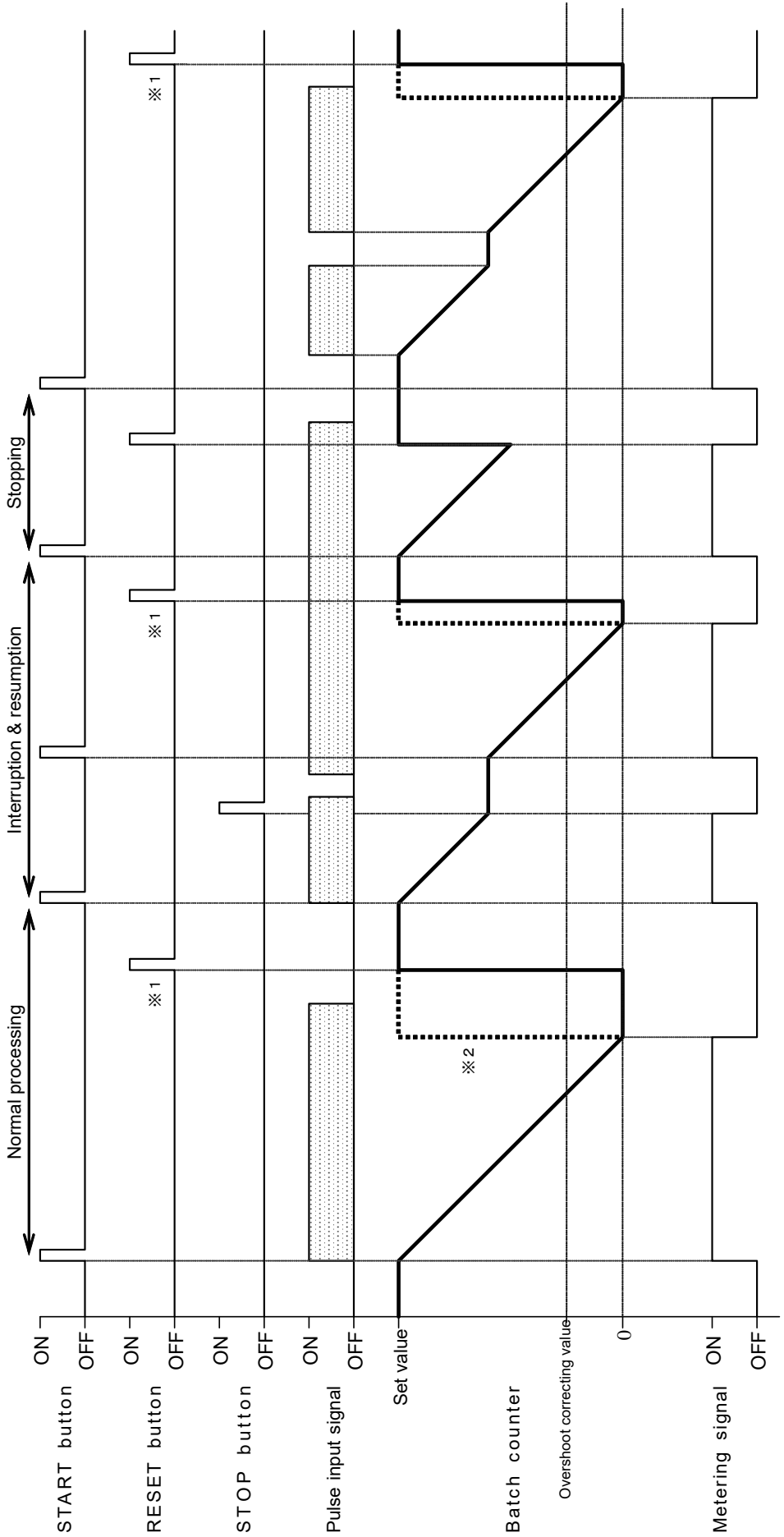

※ 1 : There is no need of resetting in the case of automatic reset system with no change to the set value.

※ 2 : " " indicates a case of automatic reset system.

7. Data setting method

Unit of integration, etc. can be changed on this flow meter by changing the contents of set items in the data setting mode.

7.1 List of set items

| Item Group name | 1 | 2 | 3 | 4 | 5 | 6 | 7 | 8 | 9 | Error indication |
|---------------------------------|----------------------------------|-------------------------|------------------------------------|----------------------------|----------------------------------------------|-----------------------------|-------------------------|--------------------------|------------------|----------------------|
| A Integration | Unit of integration | | | | | | | | | Error indication * 1 |
| b Momentary flow rate | Switching of momentary flow rate | Unit of flow rate (/h) | Unit of flow rate (/min) | 0 ~ 100% Span | Low cutoff | Upper limit alarm value | Lower limit alarm value | | | Error indication * 1 |
| C Output | Contents of SIG1 output | Contents of SIG2 output | Pulse unit | | SIG1 Pulse width adjustment | SIG2 Pulse width adjustment | | | | Error indication * 1 |
| d Batch | Simple batch ON/OFF *2 | Automatic reset ON/OFF | Overshoot count ON/OFF | Overshoot correcting value | | | | | | Error indication * 1 |
| E Processing | Viscosity (Decimal) *3 | Viscosity (Index) *3 | | | Momentary flow rate indication updating time | Alarm updating time | Reading of FLASH | Writing in FLASH | hibernation mode | Error indication * 1 |
| F Check | Software version | Meter factor | Simulated output ON/OFF | Simulated output value | Serial number display | | | | | Error indication * 1 |
| G Service | Segment check | Input check | Totalize while non batch operation | Battery alarm | Integrated flow | Resettable integrated flow | Serial number | Momentary flow averaging | ... | Error indication * 1 |

* 1) Display only.

* 2) Set the value of this item to OFF, for field display type, pulse & alarm output type, and analog output type.

* 3) This item can be set for type OE3E only. Other models do not show this item.



User level (it can be set by customer)



Service level (it can be set by our service engineer)

7.2 Liquid crystal indication / component and function of buttons

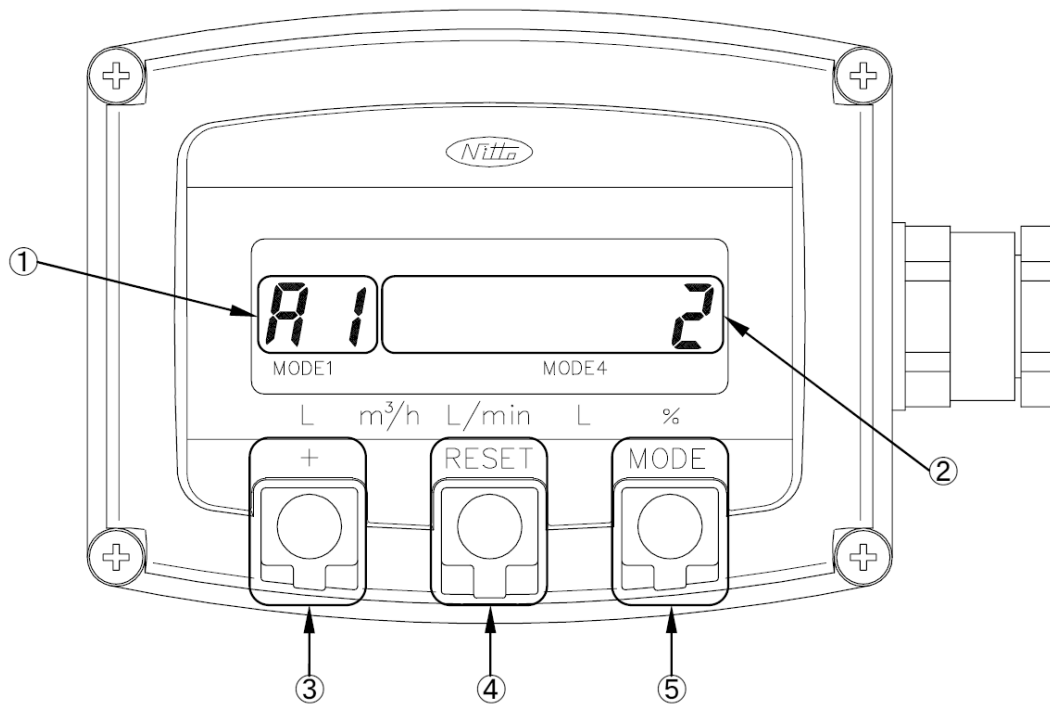

① Indication of set item No. :

Indicates the set item No.

② Indication of set contents :

Indicates the contents of setting.

③ "+" button :

- Used for moving group of the set item list.
- Used for changing the contents of setting.

④ RESET button :

- Used for moving digit position of the contents of setting.

⑤ MODE button

- Used for moving item in the set item list.
- Used for determining the contents of setting.
- Used for termination of the setting mode.

7.3 Operating method in setting mode

7.3.1 How to start & end setting mode

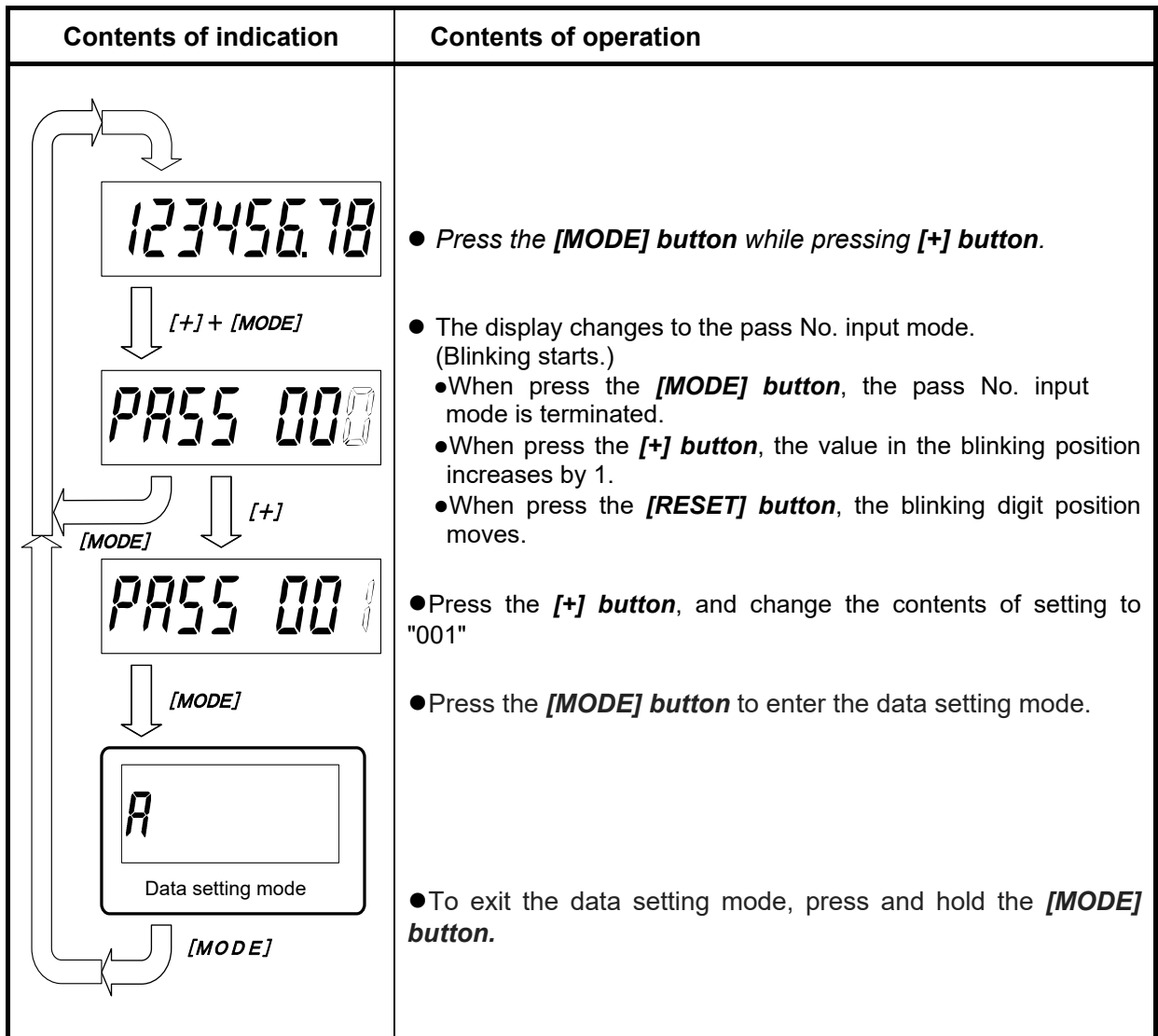

| Contents of indication | State of indication |
|------------------------|---------------------|
| | Expresses lighting |
| | Expresses blinking |

The item which can be set varies depending on the pass number.

- User level : " 0 0 1 "
- Service level : " * * * "

7.3.2 How to move set item

| Head of group | | Item | | | | | | | | Error | |
|-----------------|------------------------|------------------------|-------------------------|-------------------------|----------------------------|----------------------------------------------|-----------------------------|------------------|----------------------|----------------------|----------------------|
| Item Group name | | 1 | 2 | 3 | 4 | 5 | 6 | 7 | 8 | 9 | Error indication |
| A | Integration | Unit of integration | | | | | | | | Error indication * 1 | |
| b | Switching of flow rate | momentary flow rate | rate (/h) | rate (/min) | Space | [MODE] | Upper limit | Lower limit | Error indication * 1 | | |
| | | tents of SIG1 output | Contents of SIG2 output | Pulse unit | | SIG1 Pulse width adjustment | SIG2 Pulse width adjustment | | | Error indication * 1 | |
| d | Batch | Simple batch ON/OFF *2 | Automatic reset ON/OFF | Overshoot count ON/OFF | Overshoot correcting value | | | | | Error indication * 1 | |
| E | Processing | Viscosity (Decimal) *3 | Viscosity (Index) *3 | | | Momentary flow rate indication updating time | Alarm updating time | Reading of FLASH | Writing in FLASH | hibernation mode | Error indication * 1 |
| F | Check | Software version | Meter factor | Simulated output ON/OFF | Simulated output value | Serial number display | | | Error indication * 1 | | |

- For moving set item, select (move) the item (row) in the group after selecting (move) the set group (column).
- For moving set group, press the **[+]** button at the head of the group.
- After moving to the head of the target group, press the **[MODE]** button to move the target item.

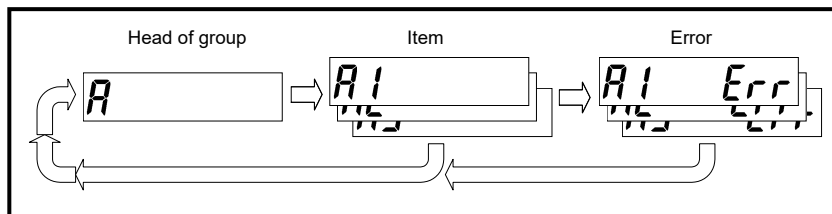

- When press the **[MODE]** button at the last item in the group, that group name and item name are displayed in case there is any error in the set item. If there is no error, display return to the head of the group.
- When press the **[MODE]** button while an error item No. is displayed, the next error item No. is displayed. When there is no more error to be displayed, display return to the head of the group.

7.4 Data setting examples

7.4.1 Setting integration unit

Set the integration unit for the **Integrated flow** (no resettable) and **Integrated flow** (resettable) display.

• Setting method:

- Set set item "A1: Unit of integration".
- Change the unit nameplate seal.





Contents of setting:

A1: Unit of integration

| Contents of setting | Unit of integration |
|---------------------|-----------------------|
| 0 | 0. 1 m L |
| 1 | 1 m L |
| 2 | 0. 0 1 L |
| 3 | 0. 1 L |
| 4 | 1 L |
| 5 | 0. 0 1 m ³ |
| 6 | 0. 1 m ³ |
| 7 | 1 m ³ |

Note) • The unit of integration available for setting varies depending on the flow meter type and nominal size. For the possible range of setting, refer to the paragraph of "Data A: Parameter list, A1. Unit of integration".

Example: Changing the unit of integration from 0.1L to 0.01m³

| Contents of indication | Contents of operation |
|-------------------------------------------------------------------------------------|---------------------------------------------------------------------------------------------------------------------------------------------------------------------------------|
|  | <ul style="list-style-type: none"> • Move to set item "A1: Unit of integration" |
|  | <ul style="list-style-type: none"> • Display switch to the Data change mode by pressing the [RESET] button. (The contents of setting start blinking.) |
|  | <ul style="list-style-type: none"> • Press the [+] button twice to change the contents of setting to 5. |
|  | <ul style="list-style-type: none"> • Press the [MODE] button to save the data. (The contents of setting stop blinking.) |

7.4.2 Setting momentary flow rate unit

Set the momentary flow rate unit.

Setting method:

- Set set item "b1: Switching of momentary flow rate".
 - At "b1: Switching of momentary flow rate" = 0, set set item "b2: Unit of flow rate (/h)".
 - At "b1: Switching of momentary flow rate" = 1, set set item "b3: Unit of flow rate (/min)".
- Change the unit nameplate seal.

Note) When the momentary flow rate unit has been changed, it is necessary to also change other set items using unit of momentary flow rate.

Set items requiring change: b4: 0~100% span
b6: Upper limit alarm value
b7: Lower limit alarm value

Contents of setting:

b1: Switching of momentary flow rate

| Contents of setting | Momentary flow rate mode |
|---------------------|----------------------------|
| 0 | Momentary flow rate (/h) |
| 1 | Momentary flow rate (/min) |

b2: Unit of flow rate (/h)



| Contents of setting | Unit of momentary flow rate |
|---------------------|-----------------------------|
| 0 | 0. 1 mL/h |
| 1 | 1 mL/h |
| 2 | 0. 0 1 L/h |
| 3 | 0. 1 L/h |
| 4 | 1 L/h |
| 5 | 0. 0 1 m ³ /h |
| 6 | 0. 1 m ³ /h |
| 7 | 1 m ³ /h |

b3: Unit of flow rate (/min)

| Contents of setting | Unit of momentary flow rate |
|---------------------|-----------------------------|
| 0 | 0. 1 mL/min |
| 1 | 1 mL/min |
| 2 | 0. 0 1 L/min |
| 3 | 0. 1 L/min |
| 4 | 1 L/min |
| 5 | 0. 0 1 m ³ /min |
| 6 | 0. 1 m ³ /min |
| 7 | 1 m ³ /min |

Note) The unit of momentary flow rate available for setting varies depending on the flow meter type and nominal size. For the possible range of setting, refer to the paragraph of "Data A: Parameter list, b2: Unit of flow rate (/h) and b3: Unit of flow rate (/min)".

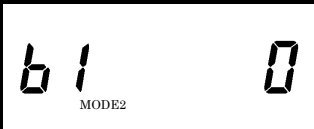
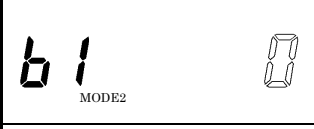
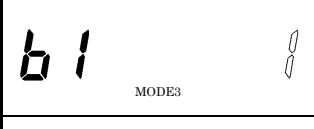
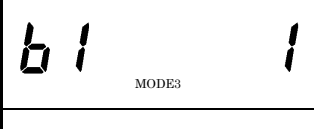
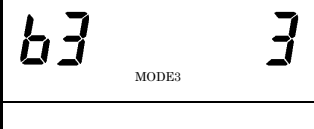
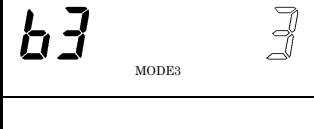
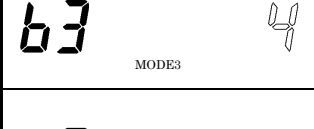
Example: Changing the unit of momentary flow rate from 0.01m³/h to 1L/min

| Contents of indication | Contents of operation |
|-------------------------------------------------------------------------------------|-----------------------------------------------------------------------------------------------------------------------------------------------------------------------------|
|  | <ul style="list-style-type: none"> ● Move to set item "b1: Switching of momentary flow rate" |
|  | <ul style="list-style-type: none"> ● Display switch to the Data change mode by pressing the [RESET] button. (The contents of setting start blinking.) |
|  | <ul style="list-style-type: none"> ● Press the [+] button once to change the contents of setting to 1. |
|  | <ul style="list-style-type: none"> ● Press the [MODE] button to save the data. (The contents of setting stop blinking.) |
|  | <ul style="list-style-type: none"> ● Press the [MODE] button and move to set item "b3: Unit of flow rate (/min)". |
|  | <ul style="list-style-type: none"> ● Display switch to the Data change mode by pressing the [RESET] button. (The contents of setting start blinking.) |
|  | <ul style="list-style-type: none"> ● Press the [+] button once to change the contents of setting to 4. |
|  | <ul style="list-style-type: none"> ● Press the [MODE] button to save the data. (The contents of setting stop blinking.) |

Example: Changing the unit of momentary flow rate from 0.01m³/h to 1L/h

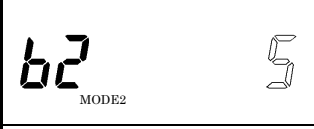
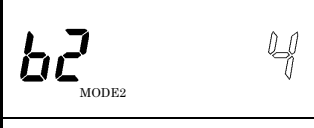
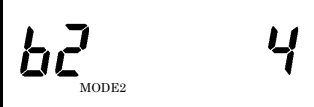
| Contents of indication | Contents of operation |
|-------------------------------------------------------------------------------------|---------------------------------------------------------------------------------------------------------------------------------------------------------------------------------------------------------------------------------------|
|  | <ul style="list-style-type: none"> ● Move to set item "b2: Unit of flow rate (/h)" |
|  | <ul style="list-style-type: none"> ● Display switch to the Data change mode by pressing the [RESET] button. (The contents of setting start blinking.) |
|  | <ul style="list-style-type: none"> ● Press the [+] button several time to change the contents of setting to 4. (The number of times of pressing of the [+] button varies depending on the nominal size.) |
|  | <ul style="list-style-type: none"> ● Press the [MODE] button, to save the data. (The contents of setting stop blinking.) |

7.4.3 Setting upper limit alarm value (or lower limit alarm value)

Set the upper limit alarm value (or lower limit alarm value).

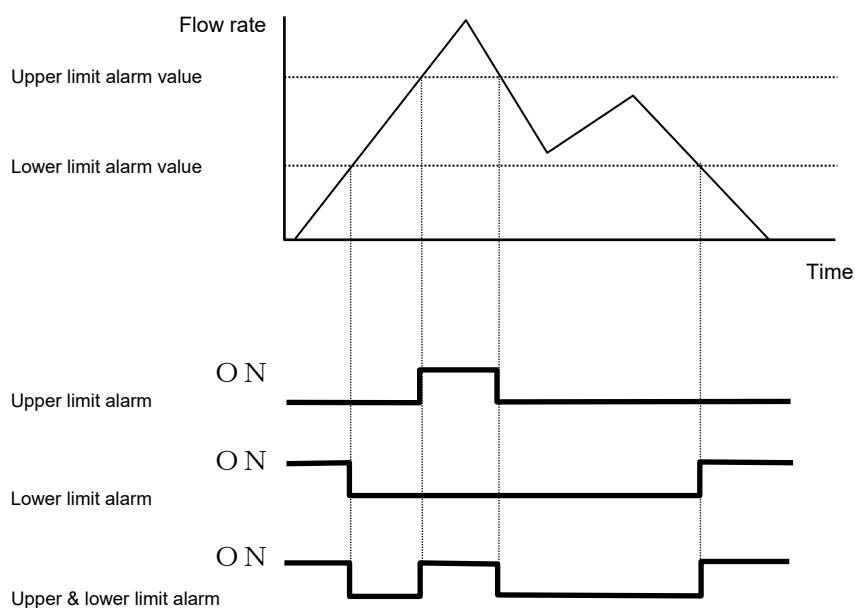

Setting method:

Upper limit alarm value: Set set item "b6: Upper limit alarm value".

Lower limit alarm value: Set set item "b7: Lower limit alarm value".

Note) The unit of set value for flow rate alarm value is the same as the unit of momentary flow rate.

Contents of setting:

| Setting range |
|-------------------------------------------------------------------------------------|
| $0 \leq \text{Lower limit alarm value} < \text{Upper limit alarm value} \leq 99999$ |

Example: Changing the upper limit flow rate alarm value from 3.00 m³/h to 6.50 m³/h

| Contents of indication | Contents of operation |
|------------------------------------------|---------------------------------------------------------------------------------------------------------------------------------------------------------------------------------|
| <p>HIGH</p> <p>66 00300</p> <p>MODE2</p> | <ul style="list-style-type: none"> ● Move to set item "b6: Upper limit alarm value". |
| <p>HIGH</p> <p>66 00300</p> <p>MODE2</p> | <ul style="list-style-type: none"> ● Display switch to the Data change mode by pressing the [RESET] button. (The contents of setting start blinking.) |
| <p>HIGH</p> <p>66 00300</p> <p>MODE2</p> | <ul style="list-style-type: none"> ● Press the [RESET] button once to move the setting digit by one position to the left. |

| | |
|-------------------------------------------|----------------------------------------------------------------------------------------------------------------------------------------------------------------|
| <p>HIGH</p> <p>66 003.50</p> <p>MODE2</p> | <ul style="list-style-type: none"> ● Press the [+] button 5 times to change the contents of the position for changing the setting to 5. |
| <p>HIGH</p> <p>66 007.50</p> <p>MODE2</p> | <ul style="list-style-type: none"> ● Press the [RESET] button once to move the setting digit by one position to the left. |
| <p>HIGH</p> <p>66 006.50</p> <p>MODE2</p> | <ul style="list-style-type: none"> ● Press the [+] button 3 times, to change the contents of the position for changing the setting to 6. |
| <p>HIGH</p> <p>66 006.50</p> <p>MODE2</p> | <ul style="list-style-type: none"> ● Press the [MODE] button to save the data. (The contents of setting stop blinking.) |

7.4.4 Setting 0 ~ 100% span (analog output span)

Set the flow rate span* for indication of momentary flow rate (MODE 5) and analog output.

* Analog output type only

Setting method:







Set set item "b4: 0 ~ 100% span".

Note) The unit of set value for span is the same as the unit of momentary flow rate.

Contents of setting:

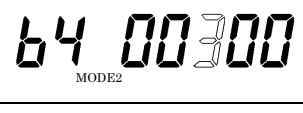
| Setting range |
|--------------------------------------------------|
| $0 < 0 \sim 100\% \text{ span value} \leq 19999$ |

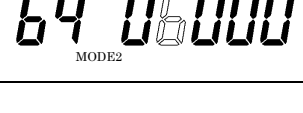
Example: Changing the 0 ~ 100% span value from 300 L/h to 6000 L/h

| Contents of indication | Contents of operation |
|-------------------------------------------------------------------------------------|---------------------------------------------------------------------------------------------------------------------------------------------------------------------------------|
|  | <ul style="list-style-type: none"> ● Move to set item "b4: 0 ~ 100% span". |
|  | <ul style="list-style-type: none"> ● Display switch to the Data change mode by pressing the [RESET] button. (The contents of setting start blinking.) |
|  | <ul style="list-style-type: none"> ● Press the [RESET] button twice to move the setting digit by two positions to the left. |
|  | <ul style="list-style-type: none"> ● Press the [+] button 7 times, to change the contents of the position for changing the setting to 0. |
|  | <ul style="list-style-type: none"> ● Press the [RESET] button once to move the setting digit by one position to the left. |
|  | <ul style="list-style-type: none"> ● Press the [+] button 6 times to change the contents of the position for changing the setting to 6. |
|  | <ul style="list-style-type: none"> ● Press the [MODE] button to save the data. (The contents of setting stop blinking.) |

7.4.5 Setting the contents of SIG1 (SIG2) output

Set the contents of output* of SIG1 (SIG2).

* Pulse & alarm output type, batch type only.

Setting method:

Contents of output of SIG1: Set set item "C1: Contents of SIG1 output"

Contents of output of SIG2: Set set item "C2: Contents of SIG2 output".

Contents of setting:

C1: Contents of SIG1 output

| Contents of setting | Contents of output |
|---------------------|---------------------------|
| --- (---) | No output |
| UnS (UnS) | Unitless pulse |
| Sc (Sc) | Unit pulse |
| hi (hi) | Upper limit alarm |
| Lo (Lo) | Lower limit alarm |
| hL (hL) | Upper & lower limit alarm |
| bAt (bAt) | Battery alarm* |

C2: Contents of SIG2 output

| Contents of setting | Contents of output |
|---------------------|---------------------------|
| --- (---) | No output |
| UnS (UnS) | Unitless pulse |
| Sc (Sc) | Unit pulse |
| hi (hi) | Upper limit alarm |
| Lo (Lo) | Lower limit alarm |
| hL (hL) | Upper & lower limit alarm |
| bAt (bAt) | Battery alarm* |

* **Built-in battery type only**

Example: Changing the contents of SIG1 output from unitless pulse to upper limit alarm

| Contents of indication | Contents of operation |
|------------------------|---------------------------------------------------------------------------------------------------------------------------------------------------------------------------------|
| C1 UnS | <ul style="list-style-type: none"> ● Move to set item "C1: Contents of SIG1 output". |
| C1 UnS | <ul style="list-style-type: none"> ● Display switch to the Data change mode by pressing the [RESET] button. (The contents of setting start blinking.) |
| C1 hi | <ul style="list-style-type: none"> ● Press the [+] button twice to change the contents of setting to "hi". |
| C1 hi | <ul style="list-style-type: none"> ● Press the [MODE] button, to save the data. (The contents of setting stop blinking.) |

7.5 Other functions and operations

(1) Changing the pulse unit of unit pulse

Setting method:

- Set set item "C3: Pulse unit".

Contents of setting:

C3: Pulse unit

| Contents of setting | Pulse unit |
|---------------------|-----------------------|
| 0 | 0. 1 m L |
| 1 | 1 m L |
| 2 | 0. 0 1 L |
| 3 | 0. 1 L |
| 4 | 1 L |
| 5 | 0. 0 1 m ³ |
| 6 | 0. 1 m ³ |
| 7 | 1 m ³ |

Note) · The unit of pulse available for setting varies depending on the flow meter type and nominal size. For the possible range of setting, refer to the paragraph of "Data A: Parameter list, C3. Pulse unit".

Example: Changing the unit of unit pulse from 0.1L to 1L

| Contents of indication | Contents of operation |
|------------------------|---------------------------------------------------------------------------------------------------------------------------------------------------------------------------------|
| C3 3 | <ul style="list-style-type: none"> • Move to set item "C3: Pulse unit". |
| C3 3 | <ul style="list-style-type: none"> • Display switch to the Data change mode by pressing the [RESET] button. (The contents of setting start blinking.) |
| C3 4 | <ul style="list-style-type: none"> • Press the [+] button once to change the contents of setting to 4. |
| C3 4 | <ul style="list-style-type: none"> • Press the [MODE] button, to save the data. (The contents of setting stop blinking.) |

(2) Changing the time of hibernation mode.

When the switch operation, liquid flow etc are not detected while set time, it enters hibernation mode. When entering the hibernation mode, the segment display disappears, but when it detects the switch operation, liquid flow etc., it exits the hibernation mode and returns the display.

Note) Using the hibernation mode reduces battery consumption and extends battery life.

Note) While the external power is supplied, it does not enter the hibernation mode even if the set time elapses.

Setting method:

- Setting item "E9: hibernation mode."

Contents of setting:

| Contents of setting | hibernation mode |
|---------------------|----------------------|
| 0 | No hibernation mode. |
| 1~9 | 1 to 9 (hours) |

Example: Change from 1 hour to no-hibernation mode.

| Contents of indication | Contents of operation |
|------------------------|-------------------------------------------------------------------------------------------------------------------------------|
| E9 1 | ● Move to set item "E9: hibernation mode". |
| E9 1 | ● Display switch to the Data change mode by pressing the [RESET] button . (The contents of setting start blinking.) |
| E9 0 | ● Press the [+] button nine times to change the contents of setting to 0. |
| E9 0 | ● Press the [MODE] button , to save the data. (The contents of setting stop blinking.) |

(3) Changing the low cutoff

The low cutoff value is set in the % value of 0 ~ 100% span (MODE 5).





Setting method:

- Set set item "b5: Low cutoff".

Contents of setting:

| Setting range |
|-----------------------------|
| 0.0 ≤ Low cutoff ≤ 99.9 (%) |

Example: Changing the low cutoff from 3.0% to 5.0%

| Contents of indication | Contents of operation |
|-------------------------------------------------------------------------------------|---------------------------------------------------------------------------------------------------------------------------------------------------------------------------------|
|  | <ul style="list-style-type: none"> • Move to set item "b5:Low cutoff". |
|  | <ul style="list-style-type: none"> • Display switch to the Data change mode by pressing the [RESET] button. (The contents of setting start blinking.) |
|  | <ul style="list-style-type: none"> • Press the [RESET] button once to move the setting digit by one position to the left. |
|  | <ul style="list-style-type: none"> • Press the [+] button twice to change the contents of setting to 5. |
|  | <ul style="list-style-type: none"> • Press the [MODE] button, to save the data. (The contents of setting stop blinking.) |

(4) Changing the momentary flow rate indication updating time

The indication of momentary flow rate is updated at every second in the standard setting. The updating of indication can be set for every second or for every momentary flow rate calculation. (At the time of delivery from the factory, it is set for updating at every second.)

Note) The updating of indication is made at a very high speed while external power is supplied. Please use with updating of indication at every second at normal times.

Setting method:

- Set set item "E5: Momentary flow rate indication updating time".

Contents of setting:

E5: Momentary flow rate indication updating time

| Set value | Contents of updating of indication |
|-----------|---------------------------------------------|
| 0 | At every calculation of momentary flow rate |
| 1 | At every second |

Example: Changing the momentary flow rate indication updating time from every second to every calculation of momentary flow rate.

| Contents of indication | Contents of operation |
|------------------------|---------------------------------------------------------------------------------------------------------------------------------------------------------------------------------|
| E5 1 | <ul style="list-style-type: none"> • Move to set item "E5: Momentary flow rate indication updating time". |
| E5 1 | <ul style="list-style-type: none"> • Display switch to the Data change mode by pressing the [RESET] button. (The contents of setting start blinking.) |
| E5 0 | <ul style="list-style-type: none"> • Press the [+] button once to change the contents of setting to 0. |
| E5 0 | <ul style="list-style-type: none"> • Press the [MODE] button to save the data. (The contents of setting stop blinking.) |

(5) Changing the alarm indication (output) updating time

The alarm indication (output) is updated at every flow rate calculation in the standard setting. The updating of alarm can be set for each momentary flow rate calculation or for every second. (The factory setting is "at every calculation of momentary flow rate".)

Setting method:



- Set set item "E6: Alarm updating time".

Contents of setting:

E6: Alarm updating time

| Set value | Contents of updating of indication |
|-----------|---------------------------------------------|
| 0 | At every calculation of momentary flow rate |
| 1 | At every second |

Example: Changing the momentary flow rate indication alarm updating time from every calculation of momentary flow rate to every second.

| Contents of indication | Contents of operation |
|----------------------------------------------------------------------------------------|-----------------------------------------------------------------------------------------------------------------------------------------------------------------------------|
| E6 0 | <ul style="list-style-type: none"> • Move to set item "E6: Alarm updating time". |
| E6  | <ul style="list-style-type: none"> • Display switch to the Data change mode by pressing the [RESET] button. (The contents of setting start blinking.) |
| E6  | <ul style="list-style-type: none"> • Press the [+] button once to change the contents of setting to 1. |
| E6 1 | <ul style="list-style-type: none"> • Press the [MODE] button to save the data. (The contents of setting stop blinking.) |

(6) To write the setting contents to FLASH.

The contents of setting items are recorded in FLASH.

By recording the setting in FLASH, even if the contents of the setting item disappears, you can read the setting contents from FLASH and restore the original setting.

- ⚠ FLASH writing or reading consumes much power. Repeated FLASH writing and reading during battery operation will shorten battery life.
- ⚠ While external power is supplied, when exiting data setting mode, it automatically writes the set value to FLASH.
- ⚠ During battery alarm indication, FLASH writing and reading may not be performed. (Except when supplying external power)

The data written to FLASH is shown in the table below.

| Group name | 1 | 2 | 3 | 4 | 5 | 6 | 7 | 8 | 9 |
|---------------------------------|----------------------------------|-------------------------|------------------------------------|----------------------------|----------------------------------------------|-----------------------------|-------------------------|------------------------------|------------------|
| A Integration | Unit of integration | | | | | | | | |
| b Momentary flow rate | Switching of momentary flow rate | Unit of flow rate (/h) | Unit of flow rate (/min) | 0 ~ 100% Span | Low cutoff | Upper limit alarm value | Lower limit alarm value | | |
| C Output | Contents of SIG1 output | Contents of SIG2 output | Pulse unit | | SIG1 Pulse width adjustment | SIG2 Pulse width adjustment | | | |
| d Batch | Simple batch ON/OFF *2 | Automatic reset ON/OFF | Overshoot count ON/OFF | Overshoot correcting value | | | | | |
| E Processing | Viscosity (Decimal) *3 | Viscosity (Index) *3 | | | Momentary flow rate indication updating time | Alarm updating time | Reading of FLASH | Writing in FLASH | hibernation mode |
| F Check | Software version | Meter factor | Simulated output ON/OFF | Simulated output value | Serial number display | | | | |
| G Service | Segment check | Input check | Totalize while non batch operation | Battery alarm | Integrated flow | Resettable Integrated flow | Serial number | Instantaneous flow averaging | ... |

Note 2) Set the value of this item to OFF, for field display type, pulse & alarm output type, and analog output type.

Note 3) This item can be set For type OE only. Other models do not show this item.



: Data recorded in FLASH

Example: Writing the contents of setting in FLASH

| Contents of indication | Contents of operation |
|------------------------|---------------------------------------------------------------------------------------------------------------------------------------------------------------|
| <i>E8 Put</i> | <ul style="list-style-type: none">● Move to set item "E8: Writing in FLASH " |
| <i>E8 Start</i> | <ul style="list-style-type: none">● Writing in FLASH starts when press the [RESET] button while pressing the [+] button. (Note 1) |
| <i>E8 End</i> | <ul style="list-style-type: none">● "End" is displayed for a few seconds when the writing in FLASH is completed. |
| <i>E8 Put</i> | <ul style="list-style-type: none">● The writing in FLASH is over. |

Note 1 In the situation where FLASH writing can not be performed, FLASH writing does not start.

(7) To read the contents of setting from FLASH

Set set item to the contents recorded in FLASH.

By recording the contents of setting in FLASH, it is possible to read out the contents of setting from FLASH and return them to the setting even in case the contents of the set item disappeared.

- ⚠ FLASH writing or reading consumes much power. Repeated FLASH writing and reading during battery operation will shorten battery life.
- ⚠ While external power is being supplied, when exiting data setting mode, it automatically writes the set value to FLASH.
- ⚠ During battery alarm indication, FLASH writing and reading may not be performed. (Except when supplying external power)

Example: Read the contents of setting in FLASH

| Contents of indication | Contents of operation |
|------------------------|---------------------------------------------------------------------------------------------------------------------------------------------------------------------------------------------------------------|
| E7 GET | <ul style="list-style-type: none"> ● Move to set item "E7: Reading of FLASH". |
| E7 Start | <ul style="list-style-type: none"> ● Reading of FLASH starts when press the [RESET] button while pressing the [+] button. (Note 1) |
| E7 End | <ul style="list-style-type: none"> ● "End" is displayed for a few seconds when the reading from FLASH is completed. |
| E7 GET | <ul style="list-style-type: none"> ● FLASH reading finished. |
| E7 Err | <ul style="list-style-type: none"> ● In case of failure in reading, an indication as shown on the left will be given for a few seconds. Make the FLASH reading operation again in such a case. |

Note 1 In situations where FLASH reading can not be performed, FLASH reading will not start.

7.6 Function and operation of batch type

⚠ Electronic Flow Meter for Small Flow Rate "Nico Eye" (Type: NE3E) does not have batch type.

(1) To use simplified batch function

Set ON, OFF of the simple batch function.

Note) Set OFF for Field indication type pulse & alarm output type and analog output type.

Setting method:

- Set set item "d1: Simple batch".

Contents of setting:

d1: Simple batch function

| Contents of setting | Simplified batch |
|---------------------|----------------------|
| <i>off</i> (oFF) | Not use simple batch |
| <i>on</i> (On) | Use simple batch |

Example: Changing simple batch from Off to On

| Contents of indication | Contents of operation |
|------------------------|---------------------------------------------------------------------------------------------------------------------------------------------------------------------------------|
| <i>d1 OFF</i> | <ul style="list-style-type: none"> • Move to set item "d1: Simple batch". |
| <i>d1 OFF</i> | <ul style="list-style-type: none"> • Display switch to the Data change mode by pressing the [RESET] button. (The contents of setting start blinking.) |
| <i>d1 On</i> | <ul style="list-style-type: none"> • Press the [+] button once to change the contents of setting to On. |
| <i>d1 On</i> | <ul style="list-style-type: none"> • Press the [MODE] button to save the data. (The contents of setting stop blinking.) |

(2) Changing the reset system

Set ON, OFF of automatic reset.

Setting method:

- Set set item "d2: Automatic reset".

Contents of setting:

d2: Automatic reset

| Contents of setting | Automatic reset |
|---------------------|-------------------------------------------|
| <i>OFF</i> (OFF) | Not automatic reset (Manual reset system) |
| <i>On</i> (On) | Automatic reset (Auto reset system) |

Example: Changing automatic reset from ON to OFF

| Contents of indication | Contents of operation |
|------------------------|---------------------------------------------------------------------------------------------------------------------------------------------------------------------------------|
| <i>d2</i> <i>On</i> | <ul style="list-style-type: none"> • Move to set item "d2: Automatic reset" |
| <i>d2</i> <i>On</i> | <ul style="list-style-type: none"> • Display switch to the Data change mode by pressing the [RESET] button. (The contents of setting start blinking.) |
| <i>d2</i> <i>OFF</i> | <ul style="list-style-type: none"> • Press the [+] button once, to change the contents of setting to OFF. |
| <i>d2</i> <i>OFF</i> | <ul style="list-style-type: none"> • Press the [MODE] button, to save the data. (The contents of setting stop blinking.) |

(3) Changing the counting system

Set ON, OFF of the counting system.

Setting method:

- Set set item "d3: Overshoot count".

Contents of setting:

d3: Overshoot count

| Contents of setting | Counting system |
|---------------------|----------------------------------------------------|
| <i>OFF</i> (OFF) | Not counting overshoot (Overshoot no-count system) |
| <i>On</i> (On) | Counting overshoot (Overshoot count system) |

Example: Changing counting system from OFF to ON

| Contents of indication | Contents of operation |
|------------------------|---------------------------------------------------------------------------------------------------------------------------------------------------------------------------------|
| <i>d3 OFF</i> | <ul style="list-style-type: none"> • Move to set item "d3: Overshoot count" |
| <i>d3 OFF</i> | <ul style="list-style-type: none"> • Display switch to the Data change mode by pressing the [RESET] button. (The contents of setting start blinking.) |
| <i>d3 On</i> | <ul style="list-style-type: none"> • Press the [+] button once, to change the contents of setting to ON. |
| <i>d3 On</i> | <ul style="list-style-type: none"> • Press the [MODE] button, to save the data. (The contents of setting stop blinking.) |

(4) Setting the overshoot amount correcting value

Set amount of overshoot (pulse number) in the case where the setting of reset system is manual resetting and the setting of counting system is overshoot count system.

Note) This function does not work in the case where the reset system is set for automatic reset and/or the counting system is set for overshoot no-count system.

Setting method:

- Set set item "d4: Overshoot correcting value".

Contents of setting:

d4: Overshoot correcting value

| Setting range |
|-------------------------------------|
| 0 ≤ Overshoot correcting value ≤ 99 |

Example: Changing overshoot correcting value from 0 to 12

| Contents of indication | Contents of operation |
|------------------------|---------------------------------------------------------------------------------------------------------------------------------------------------------------------------------|
| d4 00 | <ul style="list-style-type: none"> • Move to set item "d4: Overshoot correcting value" |
| d4 00 | <ul style="list-style-type: none"> • Display switch to the Data change mode by pressing the [RESET] button. (The contents of setting start blinking.) |
| d4 02 | <ul style="list-style-type: none"> • Press the [+] button twice to change the contents of setting to 2. |
| d4 02 | <ul style="list-style-type: none"> • Press the [RESET] button once to move the setting digit by one position to the left. |
| d4 12 | <ul style="list-style-type: none"> • Press the [+] button once to change the contents of setting to 1. |
| d4 12 | <ul style="list-style-type: none"> • Press the [MODE] button, to save the data. (The contents of setting stop blinking.) |

7.7 Factory setting

Nominal size symbol 025A0

| Set item No. | Designation | Initial set value | Contents of initial setting |
|--------------|----------------------------------------------|-------------------|---------------------------------------------|
| A 1 | Unit of integration | 4 | 1L |
| b 1 | Switching of momentary flow rate | 0 | /h |
| b 2 | Unit of flow rate (/h) | 5 | 0.01m ³ /h |
| b 3 | Unit of flow rate (/min) | 3 | 0.1L/min |
| b 4 | 0 ~ 100% span | 002.50 | 2.50m ³ /h |
| b 5 | Low cutoff | 05.0 | 5.0% |
| b 6 | Upper limit alarm value | 002.50 | 2.50m ³ /h |
| b 7 | Lower limit alarm value | 000.50 | 0.50m ³ /h |
| C 1 | Contents of SIG1 output | UnS | Unitless pulse output |
| C 2 | Contents of SIG2 output | Sc | Unit pulse output |
| C 3 | Pulse unit | 4 | 1L/P |
| d 1 | Simple Batch *1 | OFF | Batch function unused |
| d 2 | Automatic reset | On | Automatic reset |
| d 3 | Overshoot count | OFF | Not counting overshoot |
| d 4 | Overshoot correcting value | 00 | 0 (without correction) |
| E 5 | Momentary flow rate indication updating time | 1 | At every second |
| E 6 | Alarm updating time | 0 | At every calculation of momentary flow rate |
| E 9 | Hibernation mode | 1 | Hibernation after 1 hour. |
| SIG1 | Kind of signal | | Voltage no-contact (positive logic) |
| | Pulse signal width | 5.0 | 5.0 msec |
| SIG2 | Kind of signal | | Voltage no-contact (positive logic) |
| | Pulse signal width | 5.0 | 5.0 msec |
| G 5 | Integrated flow (Non-resettable) | 00000000 | 0L |
| G 6 | Resettable integrated flow | 00000000 | 0L |

*1. Set OFF for Field indication type, pulse & alarm output type and analog output type.
Set ON for batch type.

Nominal size symbol 025B0

| Set item No. | Designation | Initial set value | Contents of initial setting |
|--------------|----------------------------------------------|-------------------|---------------------------------------------|
| A 1 | Unit of integration | 4 | 1L |
| b 1 | Switching of momentary flow rate | 0 | /h |
| b 2 | Unit of flow rate (/h) | 5 | 0.01m ³ /h |
| b 3 | Unit of flow rate (/min) | 3 | 0.1L/min |
| b 4 | 0 ~ 100% span | 005.00 | 5.00m ³ /h |
| b 5 | Low cutoff | 05.0 | 5.0% |
| b 6 | Upper limit alarm value | 005.00 | 5.00m ³ /h |
| b 7 | Lower limit alarm value | 001.00 | 1.00m ³ /h |
| C 1 | Contents of SIG1 output | UnS | Unitless pulse output |
| C 2 | Contents of SIG2 output | Sc | Unit pulse output |
| C 3 | Pulse unit | 4 | 1L/P |
| d 1 | Simple Batch *1 | OFF | Batch function unused |
| d 2 | Automatic reset | 0n | Automatic reset |
| d 3 | Overshoot count | OFF | Not counting overshoot |
| d 4 | Overshoot correcting value | 00 | 0 (without correction) |
| E 5 | Momentary flow rate indication updating time | 1 | At every second |
| E 6 | Alarm updating time | 0 | At every calculation of momentary flow rate |
| E 9 | Hibernation mode | 1 | Hibernation after 1 hour. |
| SIG1 | Kind of signal | | Voltage no-contact (positive logic) |
| | Pulse signal width | 5.0 | 5.0 msec |
| SIG2 | Kind of signal | | Voltage no-contact (positive logic) |
| | Pulse signal width | 5.0 | 5.0 msec |
| G 5 | Integrated flow (Non-resettable) | 00000000 | 0L |
| G 6 | Resettable integrated flow | 00000000 | 0L |

*1. Set OFF for Field indication type, pulse & alarm output type and analog output type.
Set ON for batch type.

Nominal size symbol 040A0

| Set item No. | Designation | Initial set value | Contents of initial setting |
|--------------|----------------------------------------------|-------------------|---------------------------------------------|
| A 1 | Unit of integration | 4 | 1L |
| b 1 | Switching of momentary flow rate | 0 | /h |
| b 2 | Unit of flow rate (/h) | 5 | 0.01m ³ /h |
| b 3 | Unit of flow rate (/min) | 3 | 0.1L/min |
| b 4 | 0 ~ 100% span | 007.00 | 7.00m ³ /h |
| b 5 | Low cutoff | 05.0 | 5.0% |
| b 6 | Upper limit alarm value | 007.00 | 7.00m ³ /h |
| b 7 | Lower limit alarm value | 001.50 | 1.50m ³ /h |
| C 1 | Contents of SIG1 output | UnS | Unitless pulse output |
| C 2 | Contents of SIG2 output | Sc | Unit pulse output |
| C 3 | Pulse unit | 4 | 1L/P |
| d 1 | Simple Batch *1 | OFF | Batch function unused |
| d 2 | Automatic reset | 0n | Automatic reset |
| d 3 | Overshoot count | OFF | Not counting overshoot |
| d 4 | Overshoot correcting value | 00 | 0 (without correction) |
| E 5 | Momentary flow rate indication updating time | 1 | At every second |
| E 6 | Alarm updating time | 0 | At every calculation of momentary flow rate |
| E 9 | Hibernation mode | 1 | Hibernation after 1 hour. |
| SIG1 | Kind of signal | | Voltage no-contact (positive logic) |
| | Pulse signal width | 5.0 | 5.0 msec |
| SIG2 | Kind of signal | | Voltage no-contact (positive logic) |
| | Pulse signal width | 5.0 | 5.0 msec |
| G 5 | Integrated flow (Non-resettable) | 00000000 | 0L |
| G 6 | Resettable integrated flow | 00000000 | 0L |

*1. Set OFF for Field indication type, pulse & alarm output type and analog output type.
Set ON for batch type.

Nominal size symbol 040B0, 050A0

| Set item No. | Designation | Initial set value | Contents of initial setting |
|--------------|----------------------------------------------|-------------------|---------------------------------------------|
| A 1 | Unit of integration *2 | 5 | 0.01m ³ |
| b 1 | Switching of momentary flow rate | 0 | /h |
| b 2 | Unit of flow rate (/h) | 6 | 0.1m ³ /h |
| b 3 | Unit of flow rate (/min) | 4 | 1L/min |
| b 4 | 0 ~ 100% span | 0015.0 | 15.0m ³ /h |
| b 5 | Low cutoff | 05.0 | 5.0% |
| b 6 | Upper limit alarm value | 0015.0 | 15.0m ³ /h |
| b 7 | Lower limit alarm value | 0003.0 | 3.0m ³ /h |
| C 1 | Contents of SIG1 output | UnS | Unitless pulse output |
| C 2 | Contents of SIG2 output | Sc | Unit pulse output |
| C 3 | Pulse unit *2 | 5 | 0.1m ³ /P |
| d 1 | Simple Batch *1 | OFF | Batch function unused |
| d 2 | Automatic reset | 0n | Automatic reset |
| d 3 | Overshoot count | OFF | Not counting overshoot |
| d 4 | Overshoot correcting value | 00 | 0 (without correction) |
| E 5 | Momentary flow rate indication updating time | 1 | At every second |
| E 6 | Alarm updating time | 0 | At every calculation of momentary flow rate |
| E 9 | Hibernation mode | 1 | Hibernation after 1 hour. |
| SIG1 | Kind of signal | | Voltage no-contact (positive logic) |
| | Pulse signal width | 5.0 | 5.0 msec |
| SIG2 | Kind of signal | | Voltage no-contact (positive logic) |
| | Pulse signal width | 5.0 | 5.0 msec |
| G 5 | Integrated flow (Non-resettable) *2 | 000000.00 | 0.01m ³ |
| G 6 | Resettable integrated flow *2 | 000000.00 | 0.01m ³ |

*1. Set OFF for Field indication type, pulse & alarm output type and analog output type.
Set ON for batch type.

*2. Initial setting for batch type is 4(1L).

Nominal size symbol 050B0

| Set item No. | Designation | Initial set value | Contents of initial setting |
|--------------|----------------------------------------------|-------------------|---------------------------------------------|
| A 1 | Unit of integration *2 | 5 | 0.01m ³ |
| b 1 | Switching of momentary flow rate | 0 | /h |
| b 2 | Unit of flow rate (/h) | 6 | 0.1m ³ /h |
| b 3 | Unit of flow rate (/min) | 4 | 1L/min |
| b 4 | 0 ~ 100% span | 0025.0 | 25.0m ³ /h |
| b 5 | Low cutoff | 05.0 | 5.0% |
| b 6 | Upper limit alarm value | 0025.0 | 25.0m ³ /h |
| b 7 | Lower limit alarm value | 0006.0 | 6.0m ³ /h |
| C 1 | Contents of SIG1 output | UnS | Unitless pulse output |
| C 2 | Contents of SIG2 output | Sc | Unit pulse output |
| C 3 | Pulse unit *2 | 5 | 0.1m ³ /P |
| d 1 | Simple Batch *1 | OFF | Batch function unused |
| d 2 | Automatic reset | 0n | Automatic reset |
| d 3 | Overshoot count | OFF | Not counting overshoot |
| d 4 | Overshoot correcting value | 00 | 0 (without correction) |
| E 5 | Momentary flow rate indication updating time | 1 | At every second |
| E 6 | Alarm updating time | 0 | At every calculation of momentary flow rate |
| E 9 | Hibernation mode | 1 | Hibernation after 1 hour. |
| SIG1 | Kind of signal | | Voltage no-contact (positive logic) |
| | Pulse signal width | 5.0 | 5.0 msec |
| SIG2 | Kind of signal | | Voltage no-contact (positive logic) |
| | Pulse signal width | 5.0 | 5.0 msec |
| G 5 | Integrated flow (Non-resettable) *2 | 000000.00 | 0.01m ³ |
| G 6 | Resettable integrated flow *2 | 000000.00 | 0.01m ³ |

*1. Set OFF for Field indication type, pulse & alarm output type and analog output type.
Set ON for batch type.

*2. Initial setting for batch type is 4(1L).

7.8 Setting for use

In the case where you changed the set value when using the flow meter, enter the contents of setting in the following table:

| Set item No. | Designation | Set value | Contents of setting |
|--------------|----------------------------------------------|-----------|---------------------|
| A 1 | Unit of integration | | |
| b 1 | Switching of momentary flow rate | | |
| b 2 | Unit of flow rate (/h) | | |
| b 3 | Unit of flow rate (/min) | | |
| b 4 | 0 ~ 100% span | | |
| b 5 | Low cutoff | | |
| b 6 | Upper limit alarm value | | |
| b 7 | Lower limit alarm value | | |
| C 1 | Contents of SIG1 output | | |
| C 2 | Contents of SIG2 output | | |
| C 3 | Pulse unit | | |
| d 1 | Simple Batch *1 | | |
| d 2 | Automatic reset | | |
| d 3 | Overshoot count | | |
| d 4 | Overshoot correcting value | | |
| E 5 | Momentary flow rate indication updating time | | |
| E 6 | Alarm updating time | | |
| E 9 | Hibernation mode | | |
| SIG1 | Kind of signal | | |
| | Pulse signal width | | |
| SIG2 | Kind of signal | | |
| | Pulse signal width | | |

*1. Set OFF for Field indication type, pulse & alarm output type and analog output type.
Set ON for batch type.

8. Operation

8.1 Treatment before flowing of liquid

8.1.1 Checking after piping installation & wiring



Check the nameplate of the flow meter to make sure that its contents are conformable to the operating conditions. Also confirm that there is no error in the method of installation, piping connection and wiring again.

8.1.2 Flushing



To completely remove dust, weld refuse, etc. produced with piping work, remove the flow meter, install a short pipe of the same length as the distance between flow meter faces and perform flushing. After that, install the flow meter.

8.2 Precautions to take before start of operation

In the early period of operation, air inside the piping is discharged at high speed, and there are cases where the internal parts are damaged because of high-speed operation. To prevent such damage, open the respective valves slowly and evacuate air sufficiently.

[Valve opening/closing procedure]

- ① Upstream & downstream side valves → Fully close.
- ② Bypass valve → Fully open.
- ③ Upstream side valve → Slightly open.
- ④ Downstream side valve → Slightly open.
- ⑤ Flow the liquid.
- ⑥ Bypass valve → Gradually close.
- ⑦ Upstream & downstream side valves → Gradually open up to a proper flow rate in the prescribed range.



Check for any leakage from various parts, or unusual noise and vibrations from the flow

8.3 Operating precautions

8.3.1 Working flow rate



Keep the normal flow rate at approximately 70% of the maximum flow rate of the flow meter, considering fluctuations of flow rate, service life of flow meter, etc.

8.3.2 Precautions regarding use of high-temperature liquid

- (1) Retightening of bolts

When measuring a high-temperature liquid, retighten the bolts for protection against loosening of body bolts.

- (2) Prevention of burning



Warning

The body gets very hot. Take protective measures against burning.

9. Maintenance

9.1 Measuring section disassembling procedure

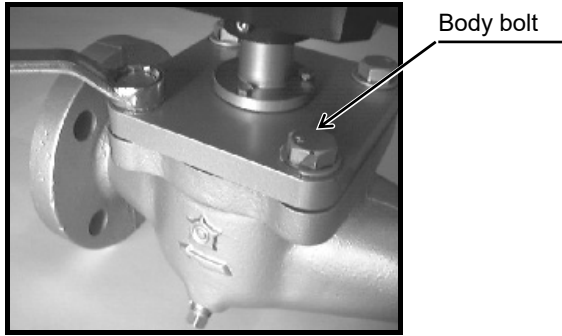

Remove all body bolts.

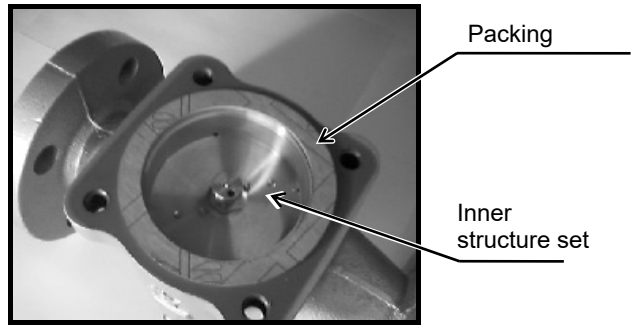

Remove the body packing, and take out the Inner structure set. Take care not to lose the knock pin.

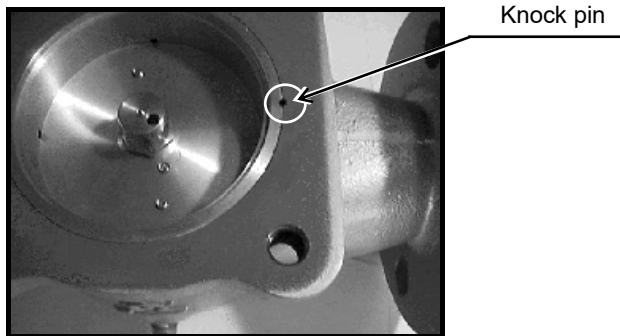

Check whether the impeller turns smoothly.

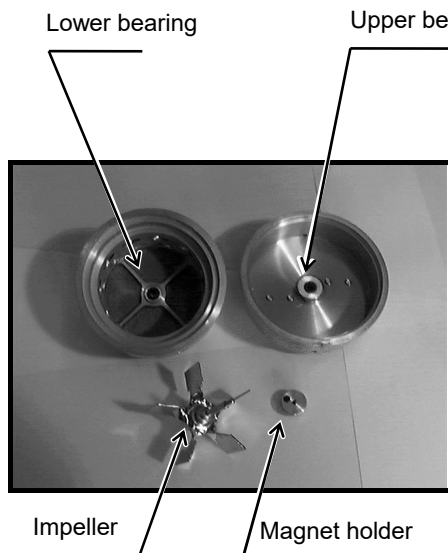

If the impeller does not turn lightly, wear of bearing, etc. is suspected. Replace defective parts to new ones.



The upper and lower inner structure set have match mark. Make the marks agree with other in the assembling.



Tighten all body bolts. The body packing must be replaced to new one without fail.

9.2 Simulated output

This flow meter has a function of simulated output for making indication and output regardless of the actual flow rate. You can check wire connection or exchange of signal with external equipment by using this function.

Note) Be sure to supply external power when using the simulated output function.

Signals available for simulated output:

● **Pulse & alarm output type**

Unit pulse
Upper limit alarm
Lower limit alarm
Upper & lower limit alarm

● **Analog output type**

Analog signal

● **Batch type**

Unit pulse
Upper limit alarm
Lower limit alarm
Upper & lower limit alarm
Metering signal 1
Metering signal 2

Note) Unitless pulse and battery alarm cannot be output by simulation.

Setting method:

- Set set item "F3: Simulated output".
- Set set item "F4: Simulated output value".
The simulated output value is set in % value of 0 ~ 100% span (MODE 5).

Contents of setting:

F3: Simulated output











| Contents of setting | Momentary flow rate mode |
|---------------------|-----------------------------|
| On (On) | Output simulated output |
| OFF (OFF) | Not output simulated output |

F4: Simulated output value



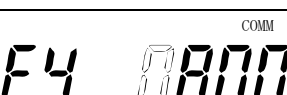

| Setting range |
|---------------------------------------------------------|
| $0.0 \leq \text{Simulated output value} \leq 199.9(\%)$ |

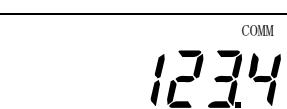
- ⚠ Blink "MODE" indication while simulated output is in operation.
- ⚠ The simulated output operation ends automatically when about 13 minutes past and shifts to normal operation.

Example: Perform simulated output value at 80%.

| Contents of indication | Contents of operation |
|-------------------------------------------------------------------------------------|------------------------------------------------------------------------------------------------------------------------------------------------------------------------------------------------------------------------|
| | <ul style="list-style-type: none"> ● Supply external power. (COMM lights.) |
|  | <ul style="list-style-type: none"> ● Move to set item "F3: Simulated output". |
|  | <ul style="list-style-type: none"> ● Display switch to the Data change mode by pressing the [RESET] button. (The contents of setting start blinking.) |
|  | <ul style="list-style-type: none"> ● Press the [+] button once to change the contents of setting to ON. |
|  | <ul style="list-style-type: none"> ● Press the [MODE] button to save the data. (The contents of setting stop blinking.) |
|  | <ul style="list-style-type: none"> ● Move to set item "F4: Simulated output value". |
|  | <ul style="list-style-type: none"> ● Display switch to the Data change mode by pressing the [RESET] button. (The contents of setting start blinking.) |
|  | <ul style="list-style-type: none"> ● Press the [RESET] button twice to move the setting changing digit by 2 positions to the left. |
|  | <ul style="list-style-type: none"> ● Press the [+] button 8 times to change the contents of setting to 8. |
|  | <ul style="list-style-type: none"> ● Press the [RESET] button once to move the setting changing digit by 1 position to the left. |
|  | <ul style="list-style-type: none"> ● Press the [+] button once to change the contents of setting to 0 |
|  | <ul style="list-style-type: none"> ● Press the [MODE] button to save the data. (The contents of setting stop blinking.) |
|  | <ul style="list-style-type: none"> ● Continue pressing the [MODE] button to end the setting mode. (Simulated output starts.) The MODE indicator blinks during a simulated output. |

Example: End simulated output

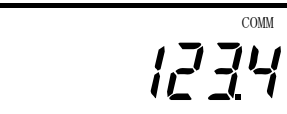
| Contents of indication | Contents of operation |
|-----------------------------------------------------------------------------------|---------------------------------------------------------------------------------------------------------------------------------------------------------------------------------|
|  | <ul style="list-style-type: none"> ● Move to set item "F3: Simulated output". |
|  | <ul style="list-style-type: none"> ● Display switch to the Data change mode by pressing the [RESET] button. (The contents of setting start blinking.) |
|  | <ul style="list-style-type: none"> ● Press the [+] button once to change the contents of setting to oFF. |
|  | <ul style="list-style-type: none"> ● Press the [MODE] button, to save the data. (The contents of setting stop blinking.) |
|  | <ul style="list-style-type: none"> ● Continue pressing the [MODE] button to end the setting mode. |

Error indication:

| Contents of indication | Contents of operation |
|------------------------------------------------------------------------------------|---------------------------------------------------------------------------------------------------------------------------------------------|
|  | <ul style="list-style-type: none"> ● External power source was cut off during a simulated output. Supply external power. |

9.3 Battery replacing procedure

If the residual capacity of the battery becomes small, "BATT" lights on the LCD display unit.

If "BATT" lit, replace the battery by the following procedure:

- (1) Turn off the external power
(when external power is supplied).

⚠ Cut off the power supply from outside before replacement work.

- (2) Remove the screw at 4 corners of the counting unit, and open the counting unit.

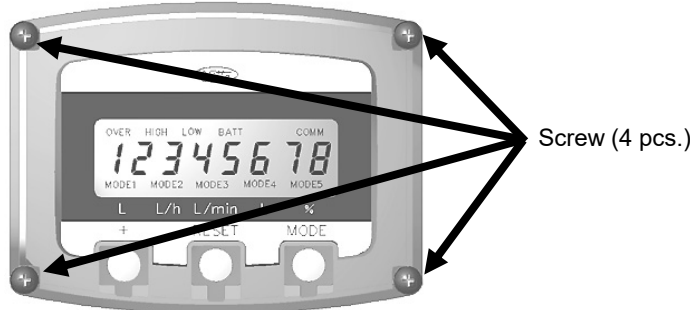

- (3) Remove the 2 screws fastening the battery.

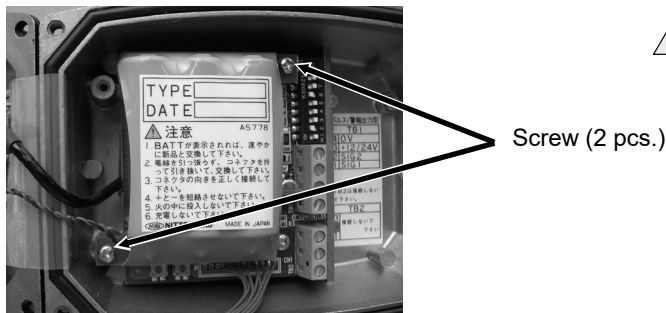

⚠ Take care not to let drop the screw(s) in the counting unit.

- (4) Remove the battery connector on the back face of the LCD display unit.

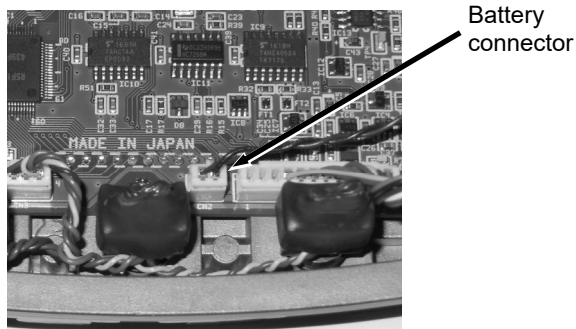

- ⚠ Extract by holding the connector.
- ⚠ Connect by checking the orientation of the connector.
- ⚠ Do not short-circuit between (+) and (-) of the battery.
- ⚠ Do not throw the battery in a fire.
- ⚠ Do not charge the battery.

- (5) Connect the connector of a new battery.

- (6) Tighten 2 screws for fastening the battery.

⚠ Take care not to pinch the cable.

- (7) Assemble the counting unit.

- (8) Supply external power (if external power was supplied before).

Note Perform the connection of battery connector within one minute.

There are cases where a battery alarm appears after replacement of the battery with a new one, but there is nothing unusual about it. (The battery alarm disappears in a few minutes.)

9.4 Counting unit resetting procedure

In case the counting unit failed to work normally, initialize the counting unit by the following procedure:

- (1) Turn off the external power (when external power is supplied). ⚠ Cut off the power supply from outside before reset work.
- (2) Remove the screw at 4 corners of the counting unit, and open the counting unit.

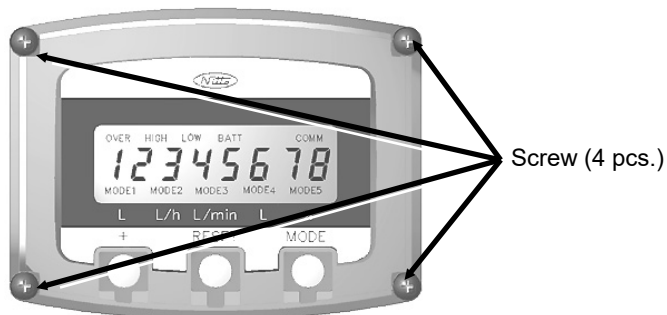

- (3) Press the reset button on the back face of the display unit.

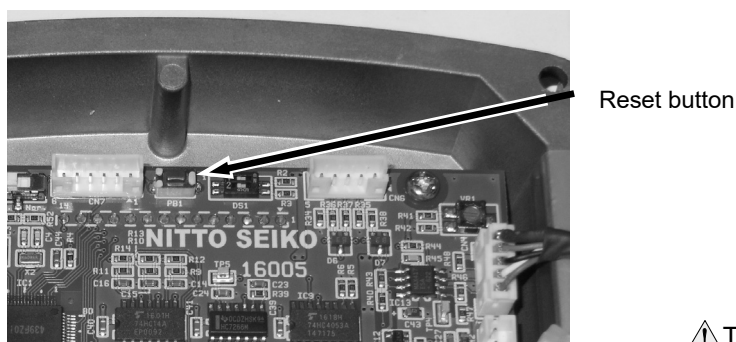

⚠ Take care not to pinch the cable.

- (4) Assemble the counting unit.
- (5) Supply external power (if external power was supplied before).



In the case where the recorded data was broken because of an operating error, the total integration, the reset integration and the respective set values change to the contents saved in FLASH with a resetting operation. When proceed resetting work, check the respective set values.

9.5 Analog output adjusting procedure

The analog output value is adjusted at the time of delivery.

In case of any deviation of the analog output value, adjust the analog output by the following procedure:

(1) Output printed circuit board

Remove the screw at 4 corners of the counting unit case and open the counting unit. There is output printed circuit board under the battery.

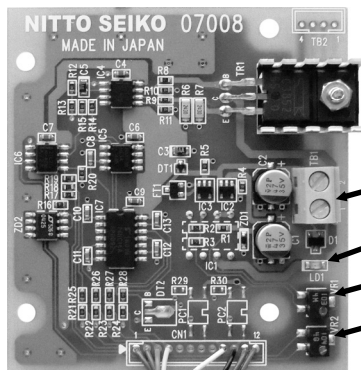
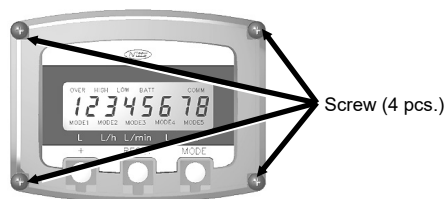

- ① Terminal block for connecting analog output
- ② External power supply LED
- ③ 4 mA adjuster
- ④ 20 mA adjuster

① Terminal block for connecting analog output (TB1)

This is a terminal block for connecting external power supply and analog signal.

② External power supply LED (LD1)

Lights when external power is supplied.

③ 4 mA adjuster (VR1)

This is an adjuster for analog output at a flow rate of 0%

④ 20 mA adjuster (VR2)

This is an adjuster for analog output at a flow rate of 100%.

(2) Contents of adjustment

● 4 mA adjuster (VR1)

| | |
|--|---------------------------------------------------------------------------------------------------------------------------------------------------------------|
| | <p>The current value increases when turn the adjuster in the clockwise direction.</p> <p>Adjust in such a way the 4 mA is indicated at a flow rate of 0%.</p> |
|--|---------------------------------------------------------------------------------------------------------------------------------------------------------------|

● 20 mA adjuster (VR2)

| | |
|--|------------------------------------------------------------------------------------------------------------------------------------------------------------------|
| | <p>The current value increases when turn the adjuster in the clockwise direction.</p> <p>Adjust in such a way the 20 mA is indicated at a flow rate of 100%.</p> |
|--|------------------------------------------------------------------------------------------------------------------------------------------------------------------|

(3) Adjusting method

1. Connect an ammeter as shown below.

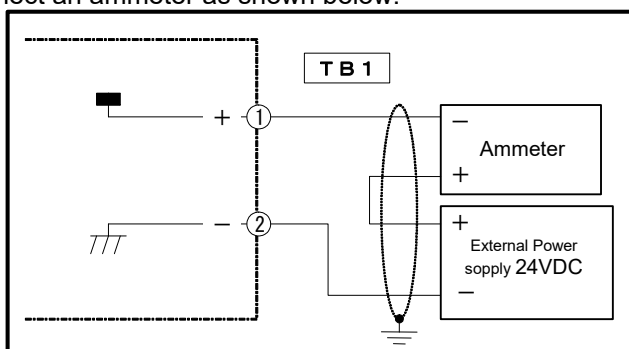

2. Supply external power, and set the flow rate at 0% by using the simulated output function. (For the method of simulated output, refer to "9.2 Simulated output".)
3. Adjust in a way to obtain a current output of 4 mA on the 4 mA adjuster (VR1).
4. Set flow rate at 100% with the simulated output function.
5. Adjust in a way to obtain a current output of 20 mA on the 20 mA adjuster (VR2).
6. Stop the simulated output function.
7. Stop the supply of external power and put back the wiring to its initial state.

9.6 Pulse width changing procedure

The pulse output signal width is adjusted to 5 ms as factory setting. To change the pulse signal width, please change according to the following procedure.

Change procedure :

1. Select the pulse signal width from the pulse signal width selection table.
2. Adjust the signal type setting SW (DS1) 4 or 8 to the desired signal width setting range.
3. Supply external power.
4. Enter "001" in the pass number on the pass number input mode and enter data setting mode.
5. Move to "Setting item C5: SIG1 pulse width adjustment" or "C6: SIG2 pulse width adjustment".
6. While checking the signal width displayed on the LCD, adjust the signal width with VR1 or VR2.

(1) Output printed circuit board

Remove the screws at 4 corners of the counting unit case and open the counting unit. There is output printed circuit board under the battery.

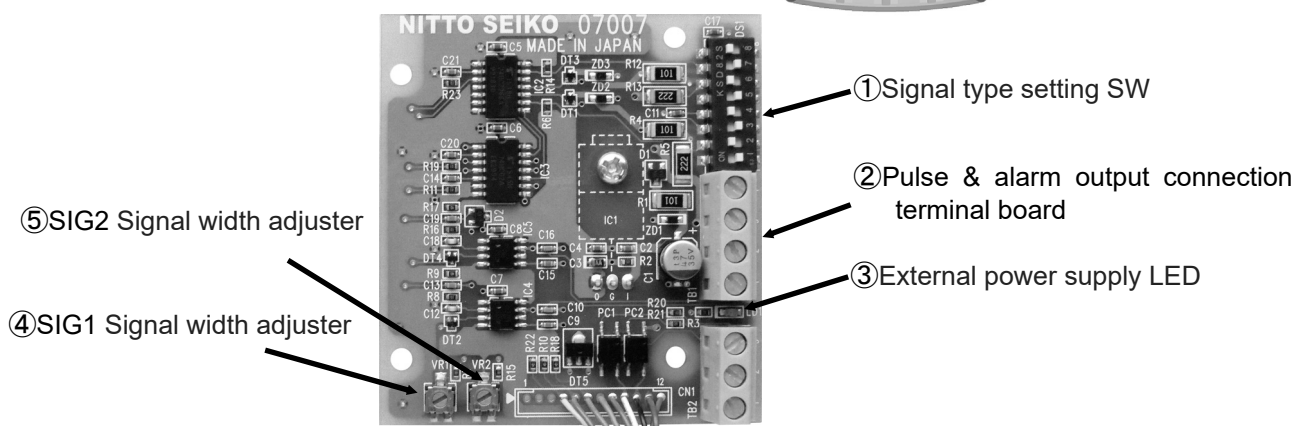
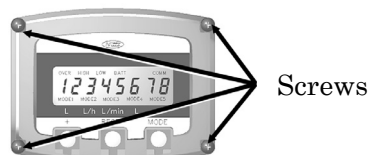

① Signal type setting SW (DS1)

Sets the signal type of SIG1, SIG2 and the range of VR1, VR2.

③ External power supply LED (LD1)

Lights when external power is supplied.

② Pulse & alarm output connection terminal board (TB1)

This is a terminal block for connecting external power supply, SIG1 signal and SIG2 signal.

④ SIG1 Signal width adjuster (VR1)

This is an adjuster for pulse width of SIG1.

⑤ SIG2 Signal width adjuster (VR2)

This is an adjuster for pulse width of SIG2.

(2) Contents of setting

●SIG 1 signal width range setting

| Contents of setting of DS1 | Signal width (VR1) Setting range |
|-------------------------------|----------------------------------|
| ON <input type="checkbox"/> 4 | Approx. 0.5~20ms |
| ON <input type="checkbox"/> 4 | Approx. 5~200ms |

●SIG2 signal width range setting

| Contents of setting of DS1 | Signal width (VR2) Setting range |
|-------------------------------|----------------------------------|
| ON <input type="checkbox"/> 8 | Approx. 0.5~20ms |
| ON <input type="checkbox"/> 8 | Approx. 5~200ms |

●SIG1 signal width adjuster (VR1)

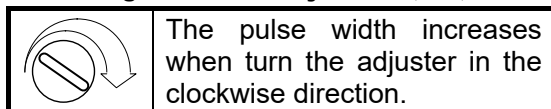

●SIG2 signal width adjuster (VR2)

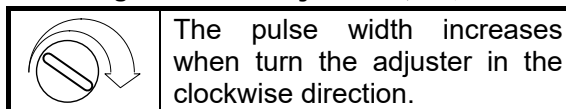

(3) Pulse signal width selection table

| Type | Nominal size & volume symbol | Mf (mL) | Max flow rate (L/h) | Output pulse unit | Pulse period (ms) | Maximum pulse width (ms) |
|------|------------------------------|---------|---------------------|-----------------------|-------------------|--------------------------|
| AE | 025A0 | 13.6 | 2,500 | 0.1 L | 137.1 | 34.3 |
| | | | | 1 L ~ | 1,429.6 | 200.0 |
| | 025B0 | 26.2 | 5,000 | 0.1 L | 56.6 | 14.1 |
| | | | | 1 L | 716.8 | 179.2 |
| | | | | 0.01 m ³ ~ | 7,187.2 | 200.0 |
| | 040A0 | 29.7 | 7,000 | 0.1 L | 45.8 | 11.5 |
| | | | | 1 L | 504.1 | 126.0 |
| | | | | 0.01 m ³ ~ | 5,132.2 | 200.0 |
| | 040B0 | 79.5 | 15,000 | 1 L | 229.0 | 57.2 |
| | | | | 0.01 m ³ ~ | 2,385.0 | 200.0 |
| | 050A0 | 79.5 | 15,000 | 1 L | 229.0 | 57.2 |
| | | | | 0.01 m ³ ~ | 2,385.0 | 200.0 |
| | 050B0 | 113.3 | 25,000 | 1 L | 130.5 | 32.6 |
| | | | | 0.01 m ³ ~ | 1,435.7 | 200.0 |

⚠ Do not set the pulse width longer than the maximum pulse width specified in the pulse width table. Pulse may overlap, and normal pulse signal may not be output.

⚠ Alarm output is always ON (or OFF) during alarm output regardless of this setting.

Example: Change the signal width of SIG 1 from 5 ms to 100 ms.

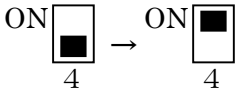
| Display content (setting content) | Operation contents |
|-----------------------------------------------------------------------------------|--------------------------------------------------------------------------------------------------------------------------------------------------------------------------------------------------------------------------------------------------------------------------------------------------------------------------------------------------------------------------------------------------------------------------------------------------------------------------------------------|
|  | <ul style="list-style-type: none"> ● Turn DS1-4 to ON. (Change the signal width setting range to Approx. 5~200 ms) |
| <p>MODE1</p> <p>COMM</p> <p>406</p> | <ul style="list-style-type: none"> ● Supply external power. (COMM lights.) |
| <p>MODE1</p> <p>COMM</p> <p>PASS 000</p> | <ul style="list-style-type: none"> ● While displaying the integrated flow or integrated flow (resettable), press the [MODE] button while pressing [+] button to switch to the pass number input mode. ● Press the [MODE] button to exit the pass number input mode. ● Press the [+] button, the value in the blinking position increases by 1. ● Press the [RESET] button, the blinking digit position moves. |
| <p>COMM</p> <p>PASS 00</p> | <ul style="list-style-type: none"> ● Set the pass number to "001". ● Press the [MODE] button to enter the data setting mode. |
| <p>COMM</p> <p>C</p> | <ul style="list-style-type: none"> ● Press the [+] button several times to move to "C output group". |
| <p>COMM</p> <p>C5</p> | <ul style="list-style-type: none"> ● Press the [MODE] button several times to move to "C 5: SIG 1 pulse width adjustment". |
| <p>COMM</p> <p>C5 1000</p> | <ul style="list-style-type: none"> ● Press the [RESET] button, and monitoring of the SIG 1 pulse width starts. ● Turn VR1 to adjust the pulse width to 100 ms. |
| <p>COMM</p> <p>C5</p> | <ul style="list-style-type: none"> ● Press the [MODE] button to end "C5: SIG1 Pulse Width Adjustment". |
| <p>MODE1</p> <p>COMM</p> <p>406</p> | <ul style="list-style-type: none"> ● Keep pressing the [MODE] button to exit the data setting mode. |

⚠ Although pulse is output from the signal output terminal during pulse width monitoring, it is not abnormal

9.7 Batch type

⚠️ Electronic Flow Meter for Small Flow Rate "Nico Eye" (Type: NE3E) does not have batch type.

9.7.1 Fuse replacing procedure

Perform replacement of fuse by the following procedure:

- (1) Turn off the power supply for metering signal 2.
- (2) Turn off the external power supply.
- (3) Remove the screw at 4 corners of the batch case on the side face of the counting unit, and open the lid.

⚠️ Cut off all external power supplies before starting the work.

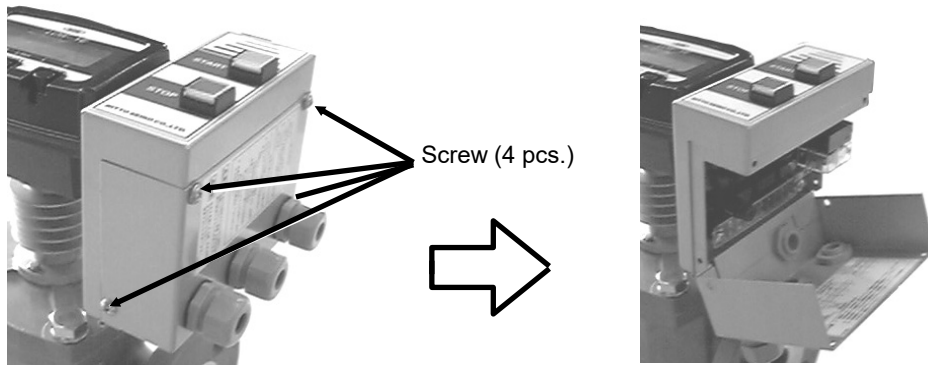

- (4) Open the lid of the fuse holder provided at the left top of TB3 by turning it in the counterclockwise direction.

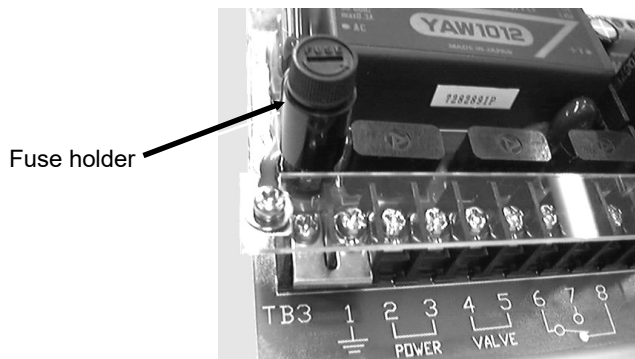

Note: The photo indicates a type of AC specification

- (5) Replace the fuse, and close the cap of the fuse holder.
- (6) Close the lid of the batch case, and tighten the screw at 4 corners.
- (7) Supply external power.
- (8) Supply power for metering signal 2.

⚠️ Take care not to pinch the cable.



Use fuse of the following specifications and type:
Slow blowing fuse 250VAC, 4A, 5.2 ϕ \times 20
Recommended manufacturer: FUJI TERMINAL INDUSTRY CO.,LTD.

9.7.2 Relay replacing procedure

Replace relay by the following procedure:

- (1) Turn off the power supply for metering signal 2.
- (2) Turn off the external power supply.
- (3) Remove the screw at 4 corners of the batch case on the side face of the counting unit, and open the lid.

 Cut off all external power supplies before starting the work.

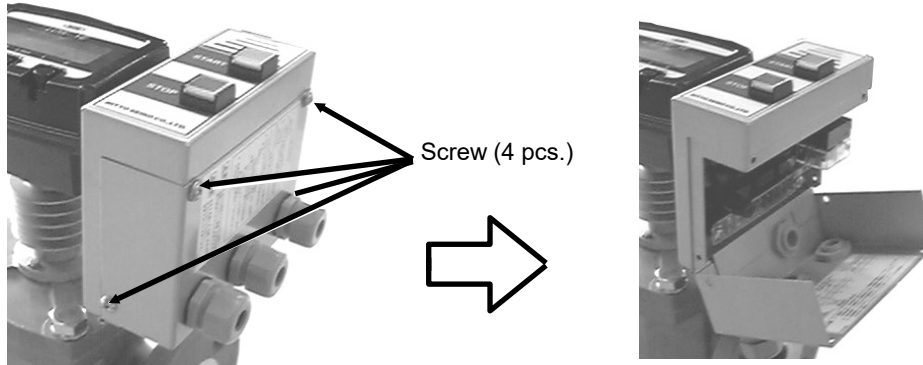

- (4) Relays are arranged at the left top of TB4. Remove the relay and replace it with a new relay of prescribed type.

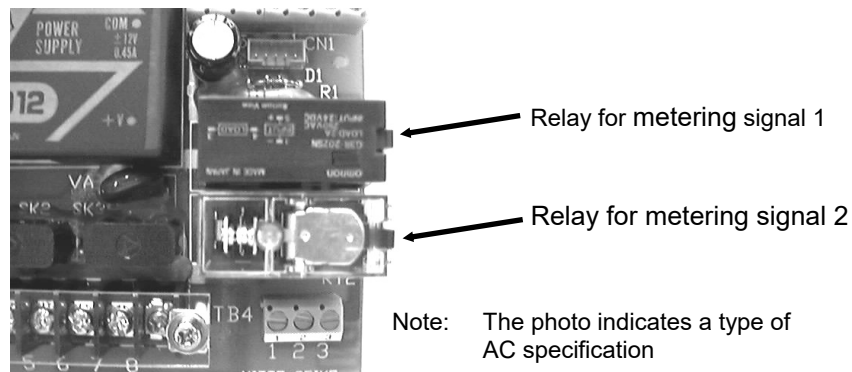

- (5) Close the lid of the batch case, and tighten the screw at 4 corners.
- (6) Supply external power.
- (7) Supply power for metering signal 2.

 Take care not to pinch the cable.



Use relay of the following specifications and type:

• **AC specification**

| | Specification | Type | Manufacturer |
|-----------------------------|-------------------|-----------------|--------------|
| Relay for metering signal 1 | Solid-state relay | G3R-202SN 24VDC | Omron |
| Relay for metering signal 2 | Power relay | G2R-1-SN 24VDC | Omron |

• **24VDC specification**

| | Specification | Type | Manufacturer |
|-----------------------------|---------------|----------------|--------------|
| Relay for metering signal 1 | Power relay | G2R-1-SN 24VDC | Omron |
| Relay for metering signal 2 | Power relay | G2R-1-SN 24VDC | Omron |

9.8 Disassembly drawing

Counting section (disassembly drawing 1)

Note: Mounting screws are not included.
Please indicate it separately if necessary.

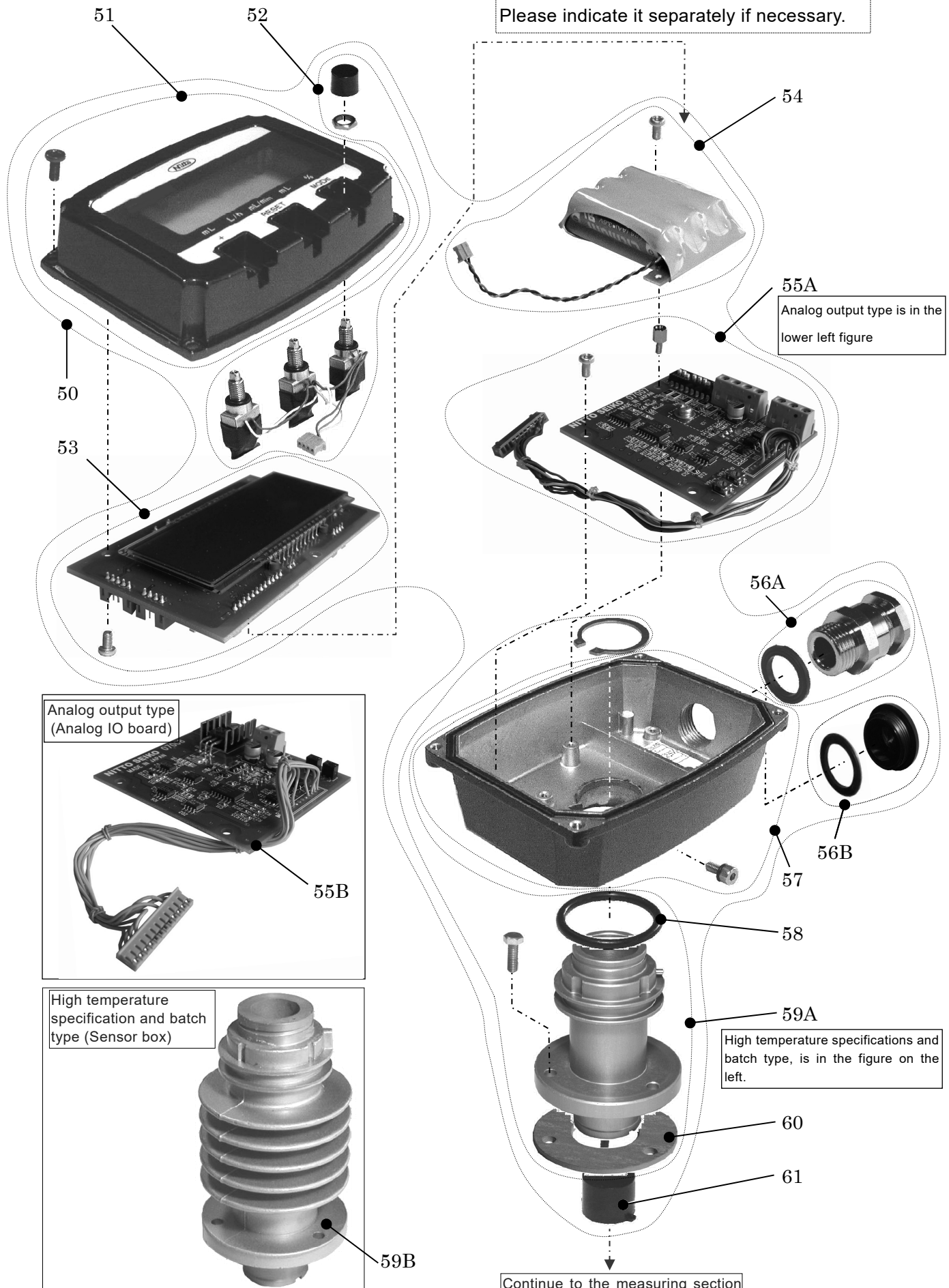

Continue to the measuring section
(disassembly drawing 3)

Counting section (disassembly drawing 2)
 [Batch type (batch part only)]

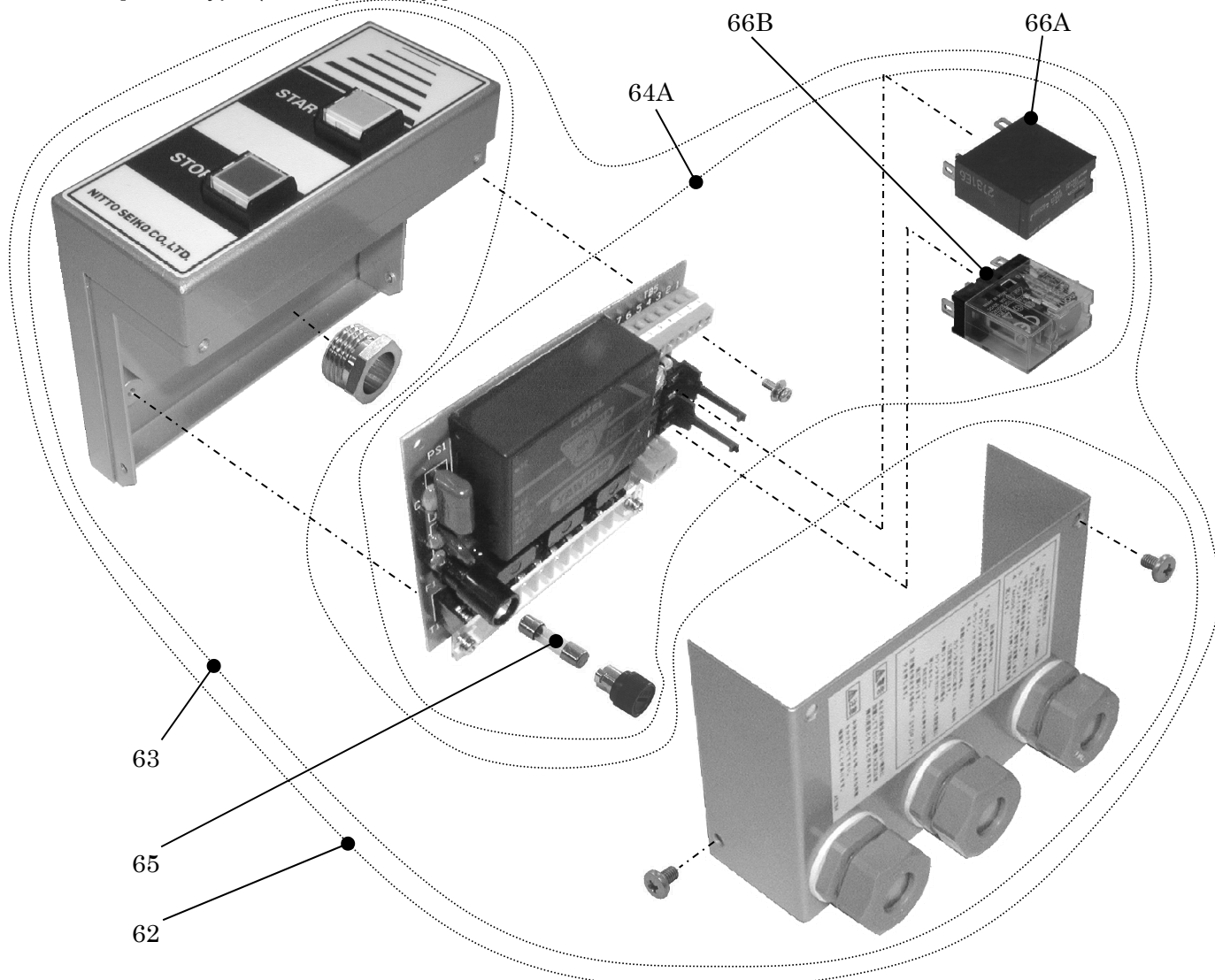

24 V DC specification

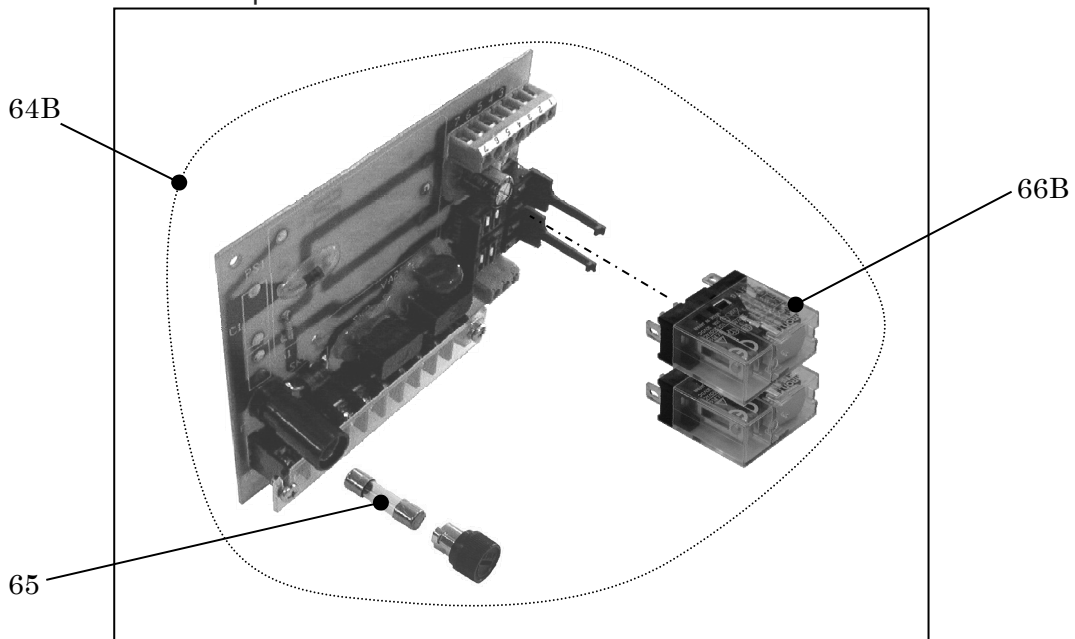

Note: Mounting screws are not included.
 Please indicate it separately if necessary.

Measuring section (disassembly drawing 3)

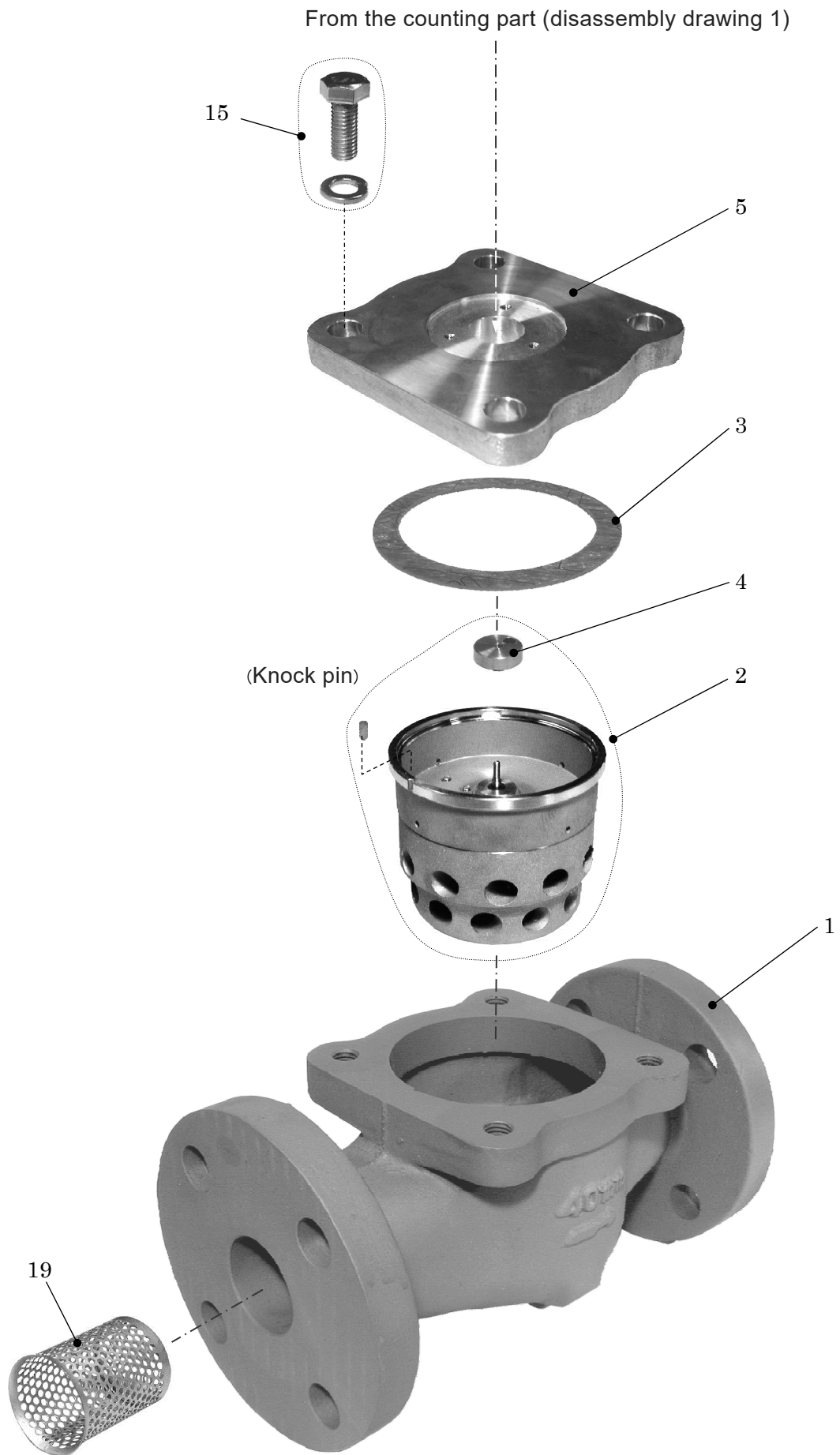

Parts name

| No. | Parts name | Q'ty | No. | Parts name | Q'ty |
|-----|---------------------------------------------------------------------|------|-----|---------------------------------------|------|
| 1 | Main body (including 19) | 1 | 57 | Lower case | 1 |
| 2 | Inner structure set | 1 | 58 | O-ring | 1 |
| 3 | Packing | 1 | 59A | Sensor box unit | 1 |
| 4 | Magnet holder | 1 | 59B | Sensor box unit (Batch type) | 1 |
| 5 | Head cover | 1 | 60 | Thermal packing | 1 |
| 15 | Body bolt | 4 | 61 | Sensor unit | 1 |
| 19 | Built-in strainer | 1 | 62 | Batch unit | 1 |
| 50 | Counting unit set | 1 | 63 | Batch box set | 1 |
| 51 | Upper case | 1 | 64A | Batch board (AC specification) | 1 |
| 52 | Push button unit | 1 | 64B | Batch board (24 VDC specification) | 1 |
| 53 | CPU board | 1 | 65 | Fuse | 1 |
| 54 | Battery unit | 1 | 66A | Solid state relay | 1(0) |
| 55A | Pulse I / O board | 1 | 66B | Power relay | 1(2) |
| 55B | Analog I / O board | 1 | | | |
| 56A | Cable ground (Pulse & alarm output type) (Analog output type) | 1 | | | |
| 56B | Blind plug (Field indication type) | 1 | | | |

10. Troubleshooting

10.1 Troubleshooting

(1) Disagreement between actual flow rate and indicated value of integration on flow meter.

| Cause | Remedy | Reference page |
|------------------------------------------------------------------------------------------------------------------------------------------------------|----------------------------------------------------------------------------------------------------------------------------------------|----------------|
| <ul style="list-style-type: none"> ● Use out of flow range | <ul style="list-style-type: none"> ● Change flow rate ● Change flow meter size | 3-2 |
| <ul style="list-style-type: none"> ● Open bypass valve ● No rise of pressure on inlet side | <ul style="list-style-type: none"> ● Check piping system. | |
| <ul style="list-style-type: none"> ● Mixing of air in measured liquid | <ul style="list-style-type: none"> ● Install air separator, etc. ● Change piping system | |
| <ul style="list-style-type: none"> ● Clogged strainer | <ul style="list-style-type: none"> ● Clean strainer element. | |
| <ul style="list-style-type: none"> ● Biting of dust and scale in rotor or impeller, and preventing these rotation. | <ul style="list-style-type: none"> ● Disassemble measuring unit, clean and inspect parts for damage. | 9-1 |
| <ul style="list-style-type: none"> ● Frozen measured liquid, preventing rotation of rotor or impeller | <ul style="list-style-type: none"> ● Install thermal insulation to the flow meter's measuring part, strainer, and pipe. | |
| <ul style="list-style-type: none"> ● Unmatching of unit of integration on flow meter (Unmatching of set item A1: Unit of integration) | <ul style="list-style-type: none"> ● Set set item A1: Unit of integration. | 7-5 |
| <ul style="list-style-type: none"> ● Flow meter in simulated output mode (MODE indication blinking) | <ul style="list-style-type: none"> ● Terminate simulated output mode. | 9-2 |

(2) Disagreement between integrated value on flow meter and output pulse number on flow meter.

| Cause | Remedy | Reference page |
|---------------------------------------------------------------------------------------------------------------------------------------------------|--------------------------------------------------------------------------------------------------------------------------------------------|----------------|
| <ul style="list-style-type: none"> ● No supply of external power | <ul style="list-style-type: none"> ● Supply external power. | 5-6 |
| <ul style="list-style-type: none"> ● Wrong wire connection | <ul style="list-style-type: none"> ● Correct connection. | 5-6 |
| <ul style="list-style-type: none"> ● Wrong signal type | <ul style="list-style-type: none"> ● Correct signal type. | 5-1 |
| <ul style="list-style-type: none"> ● Short pulse width, without counting by receiving instrument (signal width: standard 5 ms) | <ul style="list-style-type: none"> ● Change receivable signal width by the receiver. ● Adjust output signal width. | 9-8 |
| <ul style="list-style-type: none"> ● Long pulse width, with overlapping of pulses (signal width: standard 5 ms) | <ul style="list-style-type: none"> ● Adjust output signal width. | 9-8 |
| <ul style="list-style-type: none"> ● Wrong contents of output signal (Wrong contents of set item C1: SIG1 output, C2: SIG2 output) | <ul style="list-style-type: none"> ● Set contents of either set item C1: SIG1 output or C2: SIG2 output. | 7-11 |
| <ul style="list-style-type: none"> ● Wrong output pulse unit (Wrong set item C3: Pulse unit) | <ul style="list-style-type: none"> ● Set set item C3: Pulse unit. | 7-12 |
| <ul style="list-style-type: none"> ● Flow meter in simulated output mode (MODE indication blinking) | <ul style="list-style-type: none"> ● Terminate simulated output mode. | 9-2 |

(3) No change from "0" of momentary flow rate indicated on flow meter even with flowing of liquid.

| Cause | Remedy | Reference page |
|--------------------------------------------------------------------------------------------------------------------------------------------------------------------------------------------------------------------------------------|------------------------------------------------------------------------------------------------------------------------------------------------------------------|----------------|
| <ul style="list-style-type: none"> ● Use out of flow rate range | <ul style="list-style-type: none"> ● Change flow rate ● Change flow meter size | 3-2 |
| <ul style="list-style-type: none"> ● Open bypass valve ● No rise of pressure on inlet side | <ul style="list-style-type: none"> ● Check piping system. | |
| <ul style="list-style-type: none"> ● Clogged strainer | <ul style="list-style-type: none"> ● Clean strainer element. | |
| <ul style="list-style-type: none"> ● Biting of dust and scale in rotor or impeller, and preventing these rotation. | <ul style="list-style-type: none"> ● Disassemble measuring unit, clean and inspect parts for damage. | 9-1 |
| <ul style="list-style-type: none"> ● Frozen measured liquid, preventing rotation of rotor or impeller | <ul style="list-style-type: none"> ● Install thermal insulation to the flow meter's measuring part, strainer, and pipe. | |
| <ul style="list-style-type: none"> ● Unmatching of momentary flow rate unit on flow meter (Unmatching of set item b1: Switching of momentary flow rate, b2: Unit of flow rate (/h), b3: Unit of flow rate (/min)) | <ul style="list-style-type: none"> ● Set set item b1: Switching of momentary flow rate, b2: Unit of flow rate (/h), b3: Unit of flow rate (/min). | 7-6 |
| <ul style="list-style-type: none"> ● Use under low cutoff | <ul style="list-style-type: none"> ● Set set item b5: Low cutoff ● Set set item b4: 0 ~ 100% span. | 7-14 |
| <ul style="list-style-type: none"> ● Flow meter in simulated output mode (MODE indication blinking) | <ul style="list-style-type: none"> ● Terminate simulated output mode. | 9-2 |

(4) No signal output from flow meter

| Cause | Remedy | Reference page |
|---------------------------------------------------------------------------------------------------------------------------------------------------|--------------------------------------------------------------------------------------------------------------------------------------------|----------------|
| <ul style="list-style-type: none"> ● No supply of external power | <ul style="list-style-type: none"> ● Supply external power. | 5-6 |
| <ul style="list-style-type: none"> ● Wrong wire connection | <ul style="list-style-type: none"> ● Correct connection. | 5-6 |
| <ul style="list-style-type: none"> ● Wrong signal type | <ul style="list-style-type: none"> ● Correct signal type. | 5-1 |
| <ul style="list-style-type: none"> ● Short pulse width, without counting by receiving instrument (signal width: standard 5 ms) | <ul style="list-style-type: none"> ● Change signal width receivable by the receiver. ● Adjust output signal width. | 9-8 |
| <ul style="list-style-type: none"> ● Wrong contents of output signal (Wrong contents of set item C1: SIG1 output, C2: SIG2 output) | <ul style="list-style-type: none"> ● Set contents of either set item C1: SIG1 output or C2: SIG2 output. | 7-11 |
| <ul style="list-style-type: none"> ● Wrong output pulse unit (Wrong set item C3: Pulse unit) | <ul style="list-style-type: none"> ● Set set item C3: Pulse unit. | 7-12 |
| <ul style="list-style-type: none"> ● Flow meter in simulated output mode (MODE indication blinking) | <ul style="list-style-type: none"> ● Terminate simulated output mode. | 9-2 |

(5) Integrated volume agrees, but no agreement of momentary flow rate.

| Cause | Remedy | Reference page |
|---------------------------------------------------------------------------------------------------------------------------------------------------------------------------------|----------------------------------------------------------------------------------------------------------------|----------------|
| ● Unmatching of momentary flow rate unit on flow meter (Unmatching of set item b1: Switching of momentary flow rate,, b2: Unit of flow rate (/h), b3: Unit of flow rate (/min)) | ● Set set item b1: Switching of momentary flow rate,, b2: Unit of flow rate (/h), b3: Unit of flow rate (/min) | 7-6 |

(6) Disagreement between flow rate and analog output

| Cause | Remedy | Reference page |
|---------------------------------------------------------------------|------------------------------------|----------------|
| ● No supply of external power | ● Supply external power. | 5-6 |
| ● Wrong wire connection | ● Correct connection. | 5-6 |
| ● Wrong analog span (Wrong set item b4: 0 ~ 100% span) | ● Set set item b4: 0 ~ 100% span. | 7-10 |
| ● Deviation of analog output value | ● Adjust analog output value. | 9-7 |
| ● Flow meter in simulated output mode (MODE indication blinking) | ● Terminate simulated output mode. | 9-2 |

Flow meter has rotation parts such as rotor (or impeller) and bearing.

Trouble caused by the biting of dust and scale, or trouble caused by worn of frictional parts used for a long time may occurred.

We recommend to carry out daily or periodic inspection in order to maintain the accuracy at first. Interval of inspection is vary from usage and environment, but we recommend inspection every year, and recommend inspection at our factory every three year at least.

Inspection shall be carried out by the person who understand the flow meter's principle.

10.2 Confirmation items at inquiry.

When making inquiries, please record the current flow meter setting contents by doing the following work in addition to the flow meter model code and serial number of the name plate.

| Display content | Operation contents |
|-----------------|----------------------------------------------------------------------------------------------------------------------------------------------------------------------------------------------------------------------------------------------------------------------------------------------------------------------------------------------------------------------------------------------------------------------------------------------------------------------------------------------------------------------------------------------------------------------------------------------------------------------------------------------------------------------------------------------------------------------------------------------------------------------------------------------------------------------------------------|
| | <ul style="list-style-type: none"> ● Press the [MODE] button while pressing [+] button. <ul style="list-style-type: none"> ● When press the [MODE] button, the pass No. input mode is terminated. ● When press the [+] button, the value in the blinking position increases by 1. ● When press the [RESET] button, the blinking digit position moves. ● Press [+]button to change the setting to "002". ● Press [MODE]button to enter the setting content display mode. The display is switched every 10 seconds, and total of 3 screens are displayed. Please fill in the contents of each screen on the form. ● When the display of 3 screens ends, the screen returns to the normal processing screen. |

Display content

| Display example | Contents of display value | Display contents of flowmeter |
|-----------------|----------------------------------------------------------------------------------------------------------------------------------------------------------------------------------------------------------------------|-------------------------------|
| | ①b2: Unit of flow rate (/h) ②b3: Unit of flow rate (/min) ③A1: Unit of integration ④C3: Pulse unit ⑤C1: Contents of SIG1 output ⑥C2: Contents of SIG2 output ⑦B1: Switching of momentary flow rate | |
| | ①E2: Viscosity (index) ②E1: Viscosity (decimal) ③b5: Low cutoff | |
| | ①F1: Software version ②b4: 0~100%Span | |

Please also check the following contents from name plate.

| | |
|----------------------------|--|
| Type of flow meter (MODEL) | |
| Serial number (SER.No.) | |

10.3 Special display screen list

| | Display | Display content | Corrective action |
|---------------------------------------------------------|----------|---------------------------------------------------------------------------------------------------|------------------------------------------------------------------------------|
| At power on (During CPU reset processing) | StAr-t | It started up with the internal set value saved. | Please use as it is. |
| | StAr-t [| The integrated value was read from FLASH. | Please use as it is. |
| | GEt | Integrated value and internal set value were read from FLASH. | Please use as it is. |
| | LnLt | Appropriate values are set because the integrated value and the internal set value were abnormal. | Please contact us. |
| When external power is off (When battery is removed) | HALT | The operation was stopped. | Please use as it is. |
| | PUt HALT | After recording the integrated value in FLASH, the operation was stopped. | Please use as it is. |
| | PASS 000 | Entered the pass number input mode. | Please press the [MODE] button and exit the pass number setting mode. |
| | E3 Err | The external power supply was turned off during simulated output. | Please supply external power supply. |

DATA A: PARAMETER LIST

This section present all parameters used for the electronic flow meter for water.

● Contents of respective items

| Set item No. | Designation | Range & contents of data | Ref. page | Unit | Description |
|--------------|-------------|--------------------------|-----------|------|-------------|
| ① | ② | ③ | ④ | ⑤ | ⑥ |

Contents of items

| | Item | Contents |
|---|-------------------------------------|----------------------------------------------------------------------------------------------------------------------------------------|
| ① | Set item No. | Parameter No. |
| ② | Designation | Name of parameter |
| ③ | Range & contents of data | Indicates the range available for setting in the case of numeral type. Indicates selectable contents in the case of selection type. |
| ④ | Ref. page | Indicates the reference page for the setting method. |
| ⑤ | Unit | Indicates the unit of set value. Indicates the set item No. in the case of specified by other set item No. |
| ⑥ | Description | Indicates the contents of parameter. |

A. Integration group

| Set item No. | Designation | Range & contents of data | Ref. page | Unit | Description | | | | | | | | | | | | | | | | | | |
|---------------------|---------------------|----------------------------------------------------------------------------------------------------------------------------------------------------------------------------------------------------------------------------------------------------------------------------------------------------------------------------------------------------------------------------------------------------------------------------------------------------------------------|---------------------|---------------------|-------------|-------|---|-----|---|-------|---|------|---|----|---|--------------------|---|-------------------|---|-----------------|-----|--|----------------------------------------------------------------------------------------------------------------------------------------------------------------------------------------------------------------------------------------------------------------------------------------------------------------------------------------------------------------------------------------------------------------------------------------------------------------------------------|
| A 1 | Unit of integration | <table border="1"> <thead> <tr> <th>Contents of setting</th> <th>Unit of integration</th> </tr> </thead> <tbody> <tr> <td>0</td> <td>0.1mL</td> </tr> <tr> <td>1</td> <td>1mL</td> </tr> <tr> <td>2</td> <td>0.01L</td> </tr> <tr> <td>3</td> <td>0.1L</td> </tr> <tr> <td>4</td> <td>1L</td> </tr> <tr> <td>5</td> <td>0.01m³</td> </tr> <tr> <td>6</td> <td>0.1m³</td> </tr> <tr> <td>7</td> <td>1m³</td> </tr> </tbody> </table> | Contents of setting | Unit of integration | 0 | 0.1mL | 1 | 1mL | 2 | 0.01L | 3 | 0.1L | 4 | 1L | 5 | 0.01m ³ | 6 | 0.1m ³ | 7 | 1m ³ | 7-5 | | <p>Unit of indication in MODE 1, 4, and unit of batch volume for batch type</p> <p>The value available for setting varies depending on the nominal size. Nominal size: Value available for setting</p> <p>025A0:3~7(0.1L~1m³) 025B0:3~7(0.1L~1m³) 040A0:3~7(0.1L~1m³) 040B0:4~7(1L~1m³) 050A0:4~7(1L~1m³) 050B0:4~7(1L~1m³)</p> |
| Contents of setting | Unit of integration | | | | | | | | | | | | | | | | | | | | | | |
| 0 | 0.1mL | | | | | | | | | | | | | | | | | | | | | | |
| 1 | 1mL | | | | | | | | | | | | | | | | | | | | | | |
| 2 | 0.01L | | | | | | | | | | | | | | | | | | | | | | |
| 3 | 0.1L | | | | | | | | | | | | | | | | | | | | | | |
| 4 | 1L | | | | | | | | | | | | | | | | | | | | | | |
| 5 | 0.01m ³ | | | | | | | | | | | | | | | | | | | | | | |
| 6 | 0.1m ³ | | | | | | | | | | | | | | | | | | | | | | |
| 7 | 1m ³ | | | | | | | | | | | | | | | | | | | | | | |
| | | | | | | | | | | | | | | | | | | | | | | | |

b. Momentary flow rate group

| Set item No. | Designation | Range & contents of data | Ref. page | Unit | Description | | | | | | | | | | | | | | | | | | |
|---------------------|----------------------------------|-----------------------------------------------------------------------------------------------------------------------------------------------------------------------------------------------------------------------------------------------------------------------------------------------------------------------------------------------------------------------------------------------------------------------------------------------------------------------------------------------------------|---------------------|-------------------|----------------------------------------------------------------|------------|---|----------|-----|------------|----------------------------------------|-----------|---|---------|---|-------------------------|---|-------------------------|---|-----------------------|-----|----|------------------------------------------------------------------------------------------------------------------------------------------------------------------------------------------------------------------------------------------------------------------------------------------------------------------------------------------------------------------------------------------------------------------------------------------------------------------------------------|
| b 1 | Switching of momentary flow rate | <table border="1"> <thead> <tr> <th>Contents of setting</th> <th>Unit of flow rate</th> </tr> </thead> <tbody> <tr> <td>0</td> <td>/h</td> </tr> <tr> <td>1</td> <td>/min</td> </tr> </tbody> </table> | Contents of setting | Unit of flow rate | 0 | /h | 1 | /min | 7-6 | | Indication unit of momentary flow rate | | | | | | | | | | | | |
| Contents of setting | Unit of flow rate | | | | | | | | | | | | | | | | | | | | | | |
| 0 | /h | | | | | | | | | | | | | | | | | | | | | | |
| 1 | /min | | | | | | | | | | | | | | | | | | | | | | |
| b 2 | Unit of flow rate (/h) | <table border="1"> <thead> <tr> <th>Contents of setting</th> <th>Unit of flow rate</th> </tr> </thead> <tbody> <tr> <td>0</td> <td>0.1 mL/h</td> </tr> <tr> <td>1</td> <td>1 mL/h</td> </tr> <tr> <td>2</td> <td>0.01 L/h</td> </tr> <tr> <td>3</td> <td>0.1 L/h</td> </tr> <tr> <td>4</td> <td>1 L/h</td> </tr> <tr> <td>5</td> <td>0.01 m³/h</td> </tr> <tr> <td>6</td> <td>0.1 m³/h</td> </tr> <tr> <td>7</td> <td>1 m³/h</td> </tr> </tbody> </table> | Contents of setting | Unit of flow rate | 0 | 0.1 mL/h | 1 | 1 mL/h | 2 | 0.01 L/h | 3 | 0.1 L/h | 4 | 1 L/h | 5 | 0.01 m ³ /h | 6 | 0.1 m ³ /h | 7 | 1 m ³ /h | 7-6 | b1 | <p>Setting is possible when b1: Switching of momentary flow rate is at "0".</p> <p>The value available for setting varies depending on the nominal size. Nominal size: Value available for setting</p> <p>025A0: 4~6 (1L~0.1m³) 025B0: 4~6 (1L~0.1m³) 040A0: 4~6 (1L~0.1m³) 040B0: 5~7 (0.01m³~1m³) 050A0: 5~7 (0.01m³~1m³) 050B0: 5~7 (0.01m³~1m³)</p> |
| Contents of setting | Unit of flow rate | | | | | | | | | | | | | | | | | | | | | | |
| 0 | 0.1 mL/h | | | | | | | | | | | | | | | | | | | | | | |
| 1 | 1 mL/h | | | | | | | | | | | | | | | | | | | | | | |
| 2 | 0.01 L/h | | | | | | | | | | | | | | | | | | | | | | |
| 3 | 0.1 L/h | | | | | | | | | | | | | | | | | | | | | | |
| 4 | 1 L/h | | | | | | | | | | | | | | | | | | | | | | |
| 5 | 0.01 m ³ /h | | | | | | | | | | | | | | | | | | | | | | |
| 6 | 0.1 m ³ /h | | | | | | | | | | | | | | | | | | | | | | |
| 7 | 1 m ³ /h | | | | | | | | | | | | | | | | | | | | | | |
| b 3 | Unit of flow rate (/min) | <table border="1"> <thead> <tr> <th>Contents of setting</th> <th>Unit of flow rate</th> </tr> </thead> <tbody> <tr> <td>0</td> <td>0.1 mL/min</td> </tr> <tr> <td>1</td> <td>1 mL/min</td> </tr> <tr> <td>2</td> <td>0.01 L/min</td> </tr> <tr> <td>3</td> <td>0.1 L/min</td> </tr> <tr> <td>4</td> <td>1 L/min</td> </tr> <tr> <td>5</td> <td>0.01m³/min</td> </tr> <tr> <td>6</td> <td>0.1 m³/min</td> </tr> <tr> <td>7</td> <td>1 m³/min</td> </tr> </tbody> </table> | Contents of setting | Unit of flow rate | 0 | 0.1 mL/min | 1 | 1 mL/min | 2 | 0.01 L/min | 3 | 0.1 L/min | 4 | 1 L/min | 5 | 0.01m ³ /min | 6 | 0.1 m ³ /min | 7 | 1 m ³ /min | 7-6 | b1 | <p>Setting is possible when b1: Switching of momentary flow rate is at "1".</p> <p>The value available for setting varies depending on the nominal size. Nominal size: Value available for setting</p> <p>025A0: 2~4 (0.01L~1L) 025B0: 2~4 (0.01L~1L) 040A0: 2~4 (0.01L~1L) 040B0: 3~5 (0.1L~0.01m³) 050A0: 3~5 (0.1L~0.01m³) 050B0: 3~5 (0.1L~0.01m³)</p> |
| Contents of setting | Unit of flow rate | | | | | | | | | | | | | | | | | | | | | | |
| 0 | 0.1 mL/min | | | | | | | | | | | | | | | | | | | | | | |
| 1 | 1 mL/min | | | | | | | | | | | | | | | | | | | | | | |
| 2 | 0.01 L/min | | | | | | | | | | | | | | | | | | | | | | |
| 3 | 0.1 L/min | | | | | | | | | | | | | | | | | | | | | | |
| 4 | 1 L/min | | | | | | | | | | | | | | | | | | | | | | |
| 5 | 0.01m ³ /min | | | | | | | | | | | | | | | | | | | | | | |
| 6 | 0.1 m ³ /min | | | | | | | | | | | | | | | | | | | | | | |
| 7 | 1 m ³ /min | | | | | | | | | | | | | | | | | | | | | | |
| b 4 | 0 ~ 100% span | 00000 : 19999 | 7-10 | b1 b2 (b3) | Display span in MODE 5, and analog span for analog output type | | | | | | | | | | | | | | | | | | |
| b 5 | Low cutoff | 00.0 : 99.9 | 7-14 | % | Flow rate stop value Set % value of b4: 0 ~ 100% span. | | | | | | | | | | | | | | | | | | |
| b 6 | Upper limit alarm value | More than lower limit alarm value : 99999 | 7-8 | b1 b2 (b3) | | | | | | | | | | | | | | | | | | | |
| b 7 | Lower limit alarm value | 00000 : Less than upper limit alarm value | 7-8 | b1 b2 (b3) | | | | | | | | | | | | | | | | | | | |
| | | | | | | | | | | | | | | | | | | | | | | | |

C. Output group

| Set item No. | Designation | Range & contents of data | Ref. page | Unit | Description | | | | | | | | | | | | | | | | | | |
|---------------------|------------------------------------------------|------------------------------------------------------------------------------------------------------------------------------------------------------------------------------------------------------------------------------------------------------------------------------------------------------------------------------------------------------------------------------------------------------------------------------------------------------------------------------------------|---------------------|--------------------|----------------------------------------|-----------|-----|----------------|----|------------|----|-------------------|----|-------------------|----|---------------------------|-----|-----------------------|------|---------------------|---------------------------------------------------|--|-----------------------------------------------------------------------------------------------------------------------------------------------------------------------------------------------------------------------------------------------------------------------------------------------------------------------------------------------------------------------------------------------------------------|
| C 1 | Contents of SIG1 output | <table border="1"> <thead> <tr> <th>Contents of setting</th> <th>Contents of output</th> </tr> </thead> <tbody> <tr> <td>---</td> <td>No output</td> </tr> <tr> <td>Un5</td> <td>Unitless pulse</td> </tr> <tr> <td>5L</td> <td>Unit pulse</td> </tr> <tr> <td>hL</td> <td>Upper limit alarm</td> </tr> <tr> <td>Lo</td> <td>Lower limit alarm</td> </tr> <tr> <td>HL</td> <td>Upper & lower limit alarm</td> </tr> <tr> <td>bAt</td> <td>Battery alarm</td> </tr> </tbody> </table> | Contents of setting | Contents of output | --- | No output | Un5 | Unitless pulse | 5L | Unit pulse | hL | Upper limit alarm | Lo | Lower limit alarm | HL | Upper & lower limit alarm | bAt | Battery alarm | 7-11 | | bAt can be set only when equipped with a battery. | | |
| Contents of setting | Contents of output | | | | | | | | | | | | | | | | | | | | | | |
| --- | No output | | | | | | | | | | | | | | | | | | | | | | |
| Un5 | Unitless pulse | | | | | | | | | | | | | | | | | | | | | | |
| 5L | Unit pulse | | | | | | | | | | | | | | | | | | | | | | |
| hL | Upper limit alarm | | | | | | | | | | | | | | | | | | | | | | |
| Lo | Lower limit alarm | | | | | | | | | | | | | | | | | | | | | | |
| HL | Upper & lower limit alarm | | | | | | | | | | | | | | | | | | | | | | |
| bAt | Battery alarm | | | | | | | | | | | | | | | | | | | | | | |
| C 2 | Contents of SIG2 output | <table border="1"> <thead> <tr> <th>Contents of setting</th> <th>Contents of output</th> </tr> </thead> <tbody> <tr> <td>---</td> <td>No output</td> </tr> <tr> <td>Un5</td> <td>Unitless pulse</td> </tr> <tr> <td>5L</td> <td>Unit pulse</td> </tr> <tr> <td>hL</td> <td>Upper limit alarm</td> </tr> <tr> <td>Lo</td> <td>Lower limit alarm</td> </tr> <tr> <td>HL</td> <td>Upper & lower limit alarm</td> </tr> <tr> <td>bAt</td> <td>Battery alarm</td> </tr> </tbody> </table> | Contents of setting | Contents of output | --- | No output | Un5 | Unitless pulse | 5L | Unit pulse | hL | Upper limit alarm | Lo | Lower limit alarm | HL | Upper & lower limit alarm | bAt | Battery alarm | 7-11 | | bAt can be set only when equipped with a battery. | | |
| Contents of setting | Contents of output | | | | | | | | | | | | | | | | | | | | | | |
| --- | No output | | | | | | | | | | | | | | | | | | | | | | |
| Un5 | Unitless pulse | | | | | | | | | | | | | | | | | | | | | | |
| 5L | Unit pulse | | | | | | | | | | | | | | | | | | | | | | |
| hL | Upper limit alarm | | | | | | | | | | | | | | | | | | | | | | |
| Lo | Lower limit alarm | | | | | | | | | | | | | | | | | | | | | | |
| HL | Upper & lower limit alarm | | | | | | | | | | | | | | | | | | | | | | |
| bAt | Battery alarm | | | | | | | | | | | | | | | | | | | | | | |
| C 3 | Pulse unit | <table border="1"> <thead> <tr> <th>Contents of setting</th> <th>Pulse unit</th> </tr> </thead> <tbody> <tr> <td>0</td> <td>0.1 mL/p</td> </tr> <tr> <td>1</td> <td>1 mL/p</td> </tr> <tr> <td>2</td> <td>0.01 L/p</td> </tr> <tr> <td>3</td> <td>0.1 L/p</td> </tr> <tr> <td>4</td> <td>1 L/p</td> </tr> <tr> <td>5</td> <td>0.01 m³/p</td> </tr> <tr> <td>6</td> <td>0.1 m³/p</td> </tr> <tr> <td>7</td> <td>1 m³/p</td> </tr> </tbody> </table> | Contents of setting | Pulse unit | 0 | 0.1 mL/p | 1 | 1 mL/p | 2 | 0.01 L/p | 3 | 0.1 L/p | 4 | 1 L/p | 5 | 0.01 m ³ /p | 6 | 0.1 m ³ /p | 7 | 1 m ³ /p | 7-12 | | <p>The value available for setting varies depending on the nominal size.</p> <p>Nominal size: Value available for setting</p> <p>025A0: 3~7 (0.1L~1m³) 025B0: 3~7 (0.1L~1m³) 040A0: 3~7 (0.1L~1m³) 040B0: 4~7 (1L~1m³) 050A0: 4~7 (1L~1m³) 050B0: 4~7 (1L~1m³)</p> |
| Contents of setting | Pulse unit | | | | | | | | | | | | | | | | | | | | | | |
| 0 | 0.1 mL/p | | | | | | | | | | | | | | | | | | | | | | |
| 1 | 1 mL/p | | | | | | | | | | | | | | | | | | | | | | |
| 2 | 0.01 L/p | | | | | | | | | | | | | | | | | | | | | | |
| 3 | 0.1 L/p | | | | | | | | | | | | | | | | | | | | | | |
| 4 | 1 L/p | | | | | | | | | | | | | | | | | | | | | | |
| 5 | 0.01 m ³ /p | | | | | | | | | | | | | | | | | | | | | | |
| 6 | 0.1 m ³ /p | | | | | | | | | | | | | | | | | | | | | | |
| 7 | 1 m ³ /p | | | | | | | | | | | | | | | | | | | | | | |
| C 5 | SIG 1 pulse width adjustment (indication only) | 0.5 : 200.0 | 9-8 | ms | Valid when external power is supplied. | | | | | | | | | | | | | | | | | | |
| C 6 | SIG 2 pulse width adjustment (indication only) | 0.5 : 200.0 | 9-8 | ms | Valid when external power is supplied. | | | | | | | | | | | | | | | | | | |
| | | | | | | | | | | | | | | | | | | | | | | | |

d. Batch group

| Set item No. | Designation | Range & contents of data | Ref. page | Unit | Description | | | | | | |
|---------------------|----------------------------|-----------------------------------------------------------------------------------------------------------------------------------------------------------------------------------------------------------------------------------------------------|---------------------|--------------------|-------------|------------------------|-----|---------------------------|------|--|--|
| d 1 | Simple batch ON / FF | <table border="1"> <thead> <tr> <th>Contents of setting</th> <th>Contents of action</th> </tr> </thead> <tbody> <tr> <td>On</td> <td>Use simple batch</td> </tr> <tr> <td>OFF</td> <td>Not use simple batch</td> </tr> </tbody> </table> | Contents of setting | Contents of action | On | Use simple batch | OFF | Not use simple batch | 7-20 | | |
| Contents of setting | Contents of action | | | | | | | | | | |
| On | Use simple batch | | | | | | | | | | |
| OFF | Not use simple batch | | | | | | | | | | |
| d 2 | Automatic reset ON/OFF | <table border="1"> <thead> <tr> <th>Contents of setting</th> <th>Contents of action</th> </tr> </thead> <tbody> <tr> <td>On</td> <td>Auto reset system</td> </tr> <tr> <td>OFF</td> <td>Manual reset system</td> </tr> </tbody> </table> | Contents of setting | Contents of action | On | Auto reset system | OFF | Manual reset system | 7-21 | | |
| Contents of setting | Contents of action | | | | | | | | | | |
| On | Auto reset system | | | | | | | | | | |
| OFF | Manual reset system | | | | | | | | | | |
| d 3 | Overshoot count ON / OFF | <table border="1"> <thead> <tr> <th>Contents of setting</th> <th>Contents of action</th> </tr> </thead> <tbody> <tr> <td>On</td> <td>Overshoot count system</td> </tr> <tr> <td>OFF</td> <td>Overshoot no-count system</td> </tr> </tbody> </table> | Contents of setting | Contents of action | On | Overshoot count system | OFF | Overshoot no-count system | 7-22 | | |
| Contents of setting | Contents of action | | | | | | | | | | |
| On | Overshoot count system | | | | | | | | | | |
| OFF | Overshoot no-count system | | | | | | | | | | |
| d 4 | Overshoot correcting value | 00 : 99 | 7-23 | A1 | | | | | | | |
| | | | | | | | | | | | |

E. Processing group

| Set item No. | Designation | Range & contents of data | Ref. page | Unit | Description | | | | | | |
|---------------------|----------------------------------------------|--------------------------------------------------------------------------------------------------------------------------------------------------------------------------------------------------------------------------------------|---------------------|--------------------|-------------------------------------|----------------------|-----|-----------------|------|--|--|
| E 1 | Viscosity (decimal) | 0.0 : 9.9 | | | Do not change the default settings. | | | | | | |
| E 2 | Viscosity (index) | 0 : 6 | | | | | | | | | |
| E 5 | Momentary flow rate indication updating time | <table border="1"> <thead> <tr> <th>Contents of setting</th> <th>Contents of action</th> </tr> </thead> <tbody> <tr> <td>0</td> <td>At every calculation</td> </tr> <tr> <td>1</td> <td>At every second</td> </tr> </tbody> </table> | Contents of setting | Contents of action | 0 | At every calculation | 1 | At every second | 7-15 | | |
| Contents of setting | Contents of action | | | | | | | | | | |
| 0 | At every calculation | | | | | | | | | | |
| 1 | At every second | | | | | | | | | | |
| E 6 | Alarm updating time | <table border="1"> <thead> <tr> <th>Contents of setting</th> <th>Contents of action</th> </tr> </thead> <tbody> <tr> <td>0</td> <td>At every calculation</td> </tr> <tr> <td>1</td> <td>At every second</td> </tr> </tbody> </table> | Contents of setting | Contents of action | 0 | At every calculation | 1 | At every second | 7-16 | | |
| Contents of setting | Contents of action | | | | | | | | | | |
| 0 | At every calculation | | | | | | | | | | |
| 1 | At every second | | | | | | | | | | |
| E 7 | Reading of FLASH | | 7-19 | | | | | | | | |
| E 8 | Writing in FLASH | | 7-17 | | | | | | | | |
| E 9 | Hibernation mode | <table border="1"> <thead> <tr> <th>Contents of setting</th> <th>Contents of action</th> </tr> </thead> <tbody> <tr> <td>0</td> <td>No hibernate</td> </tr> <tr> <td>1~9</td> <td>1 to 9 (hours)</td> </tr> </tbody> </table> | Contents of setting | Contents of action | 0 | No hibernate | 1~9 | 1 to 9 (hours) | 7-13 | | |
| Contents of setting | Contents of action | | | | | | | | | | |
| 0 | No hibernate | | | | | | | | | | |
| 1~9 | 1 to 9 (hours) | | | | | | | | | | |
| | | | | | | | | | | | |

F. Check group

| Set item No. | Designation | Range & contents of data | Ref. page | Unit | Description | | | | | | |
|---------------------|--------------------------------------------|----------------------------------------------------------------------------------------------------------------------------------------------------------------------------------------------------------------------------------------------------------|---------------------|--------------------|------------------------------------------------------------|--------------------------|-----|------------------------------|-----|--|--|
| F 1 | Software version (indication only) | | | | | | | | | | |
| F 2 | Meter factor (indication only) | 0.0000 : 1.0000 | | | Current value of meter factor (unitless pulse output unit) | | | | | | |
| F 3 | Simulated output ON / OFF | <table border="1"> <thead> <tr> <th>Contents of setting</th> <th>Contents of action</th> </tr> </thead> <tbody> <tr> <td>On</td> <td>Output simulation signal</td> </tr> <tr> <td>OFF</td> <td>Not output simulation signal</td> </tr> </tbody> </table> | Contents of setting | Contents of action | On | Output simulation signal | OFF | Not output simulation signal | 9-2 | | |
| Contents of setting | Contents of action | | | | | | | | | | |
| On | Output simulation signal | | | | | | | | | | |
| OFF | Not output simulation signal | | | | | | | | | | |
| F 4 | Simulated output value | 000.0 : 199.9 | 9-2 | % | Set % value of b4: 0 ~ 100% | | | | | | |
| F 5 | Serial number display (indication only) | | | | | | | | | | |
| | | | | | | | | | | | |

G. Service group

| Set item No.. | Designation | Range & contents of data | Ref. page | Unit | Description | | | | | | | | |
|---------------------|------------------------------------------------------|--------------------------------------------------------------------------------------------------------------------------------------------------------------------------------------------------------------------------------------------------------------------------------|---------------------|--------------------|---------------------------------------------------------------|--------------------------------------------|-----|-------------------------------------|---|---|----------------------------------------------------------------------------------------------------------------------------------------|-----|----------------------------------|
| G 1 | Segment check (indication only) | <p>OVER HIGH LOW BATT SENS COMM</p> <p>MODE1 MODE2 MODE3 MODE4 MODE5</p> | | | Lighting of all segments | | | | | | | | |
| G 2 | Input check | | | | | | | | | | | | |
| G 3 | Totalize while non batch operation | <table border="1"> <thead> <tr> <th>Contents of setting</th> <th>Contents of action</th> </tr> </thead> <tbody> <tr> <td>On</td> <td>Totalize</td> </tr> <tr> <td>OFF</td> <td>No totalize</td> </tr> </tbody> </table> | Contents of setting | Contents of action | On | Totalize | OFF | No totalize | | | Initial value : OFF (No totalize) While simple batch is active, integration and momentary flow rate processing is performed or not. | | |
| Contents of setting | Contents of action | | | | | | | | | | | | |
| On | Totalize | | | | | | | | | | | | |
| OFF | No totalize | | | | | | | | | | | | |
| G 4 | Battery alarm (Only when external power is supplied) | <table border="1"> <thead> <tr> <th>Contents of setting</th> <th>Contents of action</th> </tr> </thead> <tbody> <tr> <td>On</td> <td>Output alarm</td> </tr> <tr> <td>OFF</td> <td>Not output alarm</td> </tr> </tbody> </table> | Contents of setting | Contents of action | On | Output alarm | OFF | Not output alarm | | | | | |
| Contents of setting | Contents of action | | | | | | | | | | | | |
| On | Output alarm | | | | | | | | | | | | |
| OFF | Not output alarm | | | | | | | | | | | | |
| G 5 | Integrated flow | 00000000 : 99999999 | | A1 | Contents of indication in MODE 1 | | | | | | | | |
| G 6 | Resettable integrated flow | 00000000 : 99999999 | | A1 | Contents of indication in MODE 4 (during no-batch processing) | | | | | | | | |
| G 7 | Serial number | | | | | | | | | | | | |
| G 8 | Momentary flow averaging | <table border="1"> <thead> <tr> <th>Contents of setting</th> <th>Contents of action</th> </tr> </thead> <tbody> <tr> <td>0</td> <td>No averaging</td> </tr> <tr> <td>1</td> <td rowspan="3">Averaging</td> </tr> <tr> <td>:</td> </tr> <tr> <td>9</td> </tr> </tbody> </table> | Contents of setting | Contents of action | 0 | No averaging | 1 | Averaging | : | 9 | | 9-2 | Initial value : 0 (No averaging) |
| Contents of setting | Contents of action | | | | | | | | | | | | |
| 0 | No averaging | | | | | | | | | | | | |
| 1 | Averaging | | | | | | | | | | | | |
| : | | | | | | | | | | | | | |
| 9 | | | | | | | | | | | | | |
| G 9 | Momentary flow Measurement mode selection | <table border="1"> <thead> <tr> <th>Contents of setting</th> <th>Contents of action</th> </tr> </thead> <tbody> <tr> <td>0</td> <td>First 1 rotation of rotor flow measurement</td> </tr> <tr> <td>1</td> <td>First pulse period flow measurement</td> </tr> </tbody> </table> | Contents of setting | Contents of action | 0 | First 1 rotation of rotor flow measurement | 1 | First pulse period flow measurement | | | Initial value : 0 (First 1 rotation of rotor flow measurement) | | |
| Contents of setting | Contents of action | | | | | | | | | | | | |
| 0 | First 1 rotation of rotor flow measurement | | | | | | | | | | | | |
| 1 | First pulse period flow measurement | | | | | | | | | | | | |
| G 10 | Pulse check | | | | | | | | | | | | |
| G 11 | Analog output check | | | | | | | | | | | | |
| | | | | | | | | | | | | | |

DATA B: SEGMENT CHARACTERS CORRESPONDENCE LIST

This section presents the characters on the segment indicating unit used for this flow meter.

| Contents of indication | Corresponding character |
|------------------------|-------------------------|
| - | - |
| 0 | 0 (O) |
| 1 | 1 |
| 2 | 2 |
| 3 | 3 |
| 4 | 4 |
| 5 | 5 (S) |
| 6 | 6 |
| 7 | 7 |
| 8 | 8 |
| 9 | 9 |
| A | A |
| b | b |
| C | C |
| c | c |
| d | d |
| E | E |
| F | F |

| Contents of indication | Corresponding character |
|------------------------|-------------------------|
| G | G |
| H | H (X) |
| h | h |
| i | i |
| J | J |
| L | L |
| n | n |
| O | O (0) |
| o | o |
| P | P |
| q | q |
| r | r |
| S | S (5) |
| t | t |
| U | U |
| u | v (u) |
| X | X (H) |
| Y | Y |

Product warranty

The products and specifications described in this document are subject to change (including specification change and production termination) without notice for product improvement. When you consider using or ordering the product described in this document, please contact us as appropriate to confirm that the information described in this document is the latest.

This product is manufactured and inspected under the appropriate quality control as an industrial instrument, and delivered. However, failure may occur due to an unexpected cause. When this product is used for process control that may cause serious problems in terms of safety, safety can be achieved by duplicating the control system, such as adding equipment that performs the same function in addition to this product. Acceptance inspection will be conducted promptly for the purchased product, and with regard to the handling before or during the acceptance inspection of this product, please give due consideration to management and maintenance.

Warranty period

The warranty period for this product is one year after delivery.

The warranty period shall start from the date of the form (delivery note, installation commission confirmation, receipt).

Scope of warranty

If a failure or defect is found in our product during this warranty period due to our responsibility, we will provide replacement products, or replace or repair the defect part free of charge.

However, if any failure or damage falls under any of the following articles, this warranty does not apply.

1. When it originates in the specification and the standard specified you, your handling method, etc.
2. In the case where the change in structure, performance, specifications, etc which carried out after purchase or delivery, and in which we are not involved.
3. When it is due to a phenomenon that cannot be foreseen by the technology that has been put into practical use on or before the time of purchase or contract.
4. When used out of range of conditions and environment described in catalogs and specifications.
5. In case where this product is used incorporated into your device and the damage could be avoided by the device function which should have in general concept.
6. Due to natural disasters or force majeure
7. Consumables such as batteries and relays, and optional items such as cables.

In addition, the warranty mentioned here is limited to the warranty of the product purchased or delivered, and the damage caused by the failure of this product or damage is excluded.

NITTOSEIKO CO.,LTD.



Control System Division Global Sales Section . [【Website】](#) [【Inquiry Form】](#)
Website: <https://global.nittoseiko.com/> .